

# Unique Insight into the Seasonal Variability of Geophysical Properties of Field Soils: Practical Implications for Near Surface Investigations

Boddice, Daniel; Metje, Nicole; Chapman, David

DOI:  
[10.3997/1873-0604.2017020](https://doi.org/10.3997/1873-0604.2017020)

License:  
None: All rights reserved

Document Version  
Peer reviewed version

Citation for published version (Harvard):  
Boddice, D, Metje, N & Chapman, D 2017, 'Unique Insight into the Seasonal Variability of Geophysical Properties of Field Soils: Practical Implications for Near Surface Investigations', *Near Surface Geophysics*, vol. 15, no. 5, pp. 515-526 . <https://doi.org/10.3997/1873-0604.2017020>

[Link to publication on Research at Birmingham portal](#)

**Publisher Rights Statement:**  
Final version of record published as above.

Checked 9/5/2017

## General rights

Unless a licence is specified above, all rights (including copyright and moral rights) in this document are retained by the authors and/or the copyright holders. The express permission of the copyright holder must be obtained for any use of this material other than for purposes permitted by law.

- Users may freely distribute the URL that is used to identify this publication.
- Users may download and/or print one copy of the publication from the University of Birmingham research portal for the purpose of private study or non-commercial research.
- User may use extracts from the document in line with the concept of 'fair dealing' under the Copyright, Designs and Patents Act 1988 (?)
- Users may not further distribute the material nor use it for the purposes of commercial gain.

Where a licence is displayed above, please note the terms and conditions of the licence govern your use of this document.

When citing, please reference the published version.

## Take down policy

While the University of Birmingham exercises care and attention in making items available there are rare occasions when an item has been uploaded in error or has been deemed to be commercially or otherwise sensitive.

If you believe that this is the case for this document, please contact [UBIRA@lists.bham.ac.uk](mailto:UBIRA@lists.bham.ac.uk) providing details and we will remove access to the work immediately and investigate.

# Unique Insight into the Seasonal Variability of Geophysical Properties of Field Soils: Practical Implications for Near Surface Investigations

Daniel Boddice<sup>1\*</sup>, Nicole Metje<sup>1</sup>, David Chapman<sup>1</sup>

1. School of Engineering, College of Engineering and Physical Sciences, University of Birmingham, Edgbaston, Birmingham, B15 2TT

\* d.boddice@bham.ac.uk

## **Abstract**

Electromagnetic (EM) wave propagation methods are extensively used in geophysical prospection, such as archaeological and utility surveys. The signal penetration and attenuation depend strongly on the apparent permittivity and electrical conductivity of the soil which vary on a seasonal basis, affecting the detection of buried features, especially their detected depth. However, there is a significant lack of high quality, long term seasonal field monitoring data of EM properties in different soil conditions to aid the understanding of how these properties vary in field conditions. The research reported in this paper provides an important step forward in addressing the scarcity of data. Long term data are presented and analysed from bespoke time domain reflectometry (TDR) monitoring stations designed to enable collection of apparent relative dielectric permittivity (ARDP), bulk electrical conductivity (BEC) and temperature data at a high temporal resolution (hourly) from three remote sites with different soils over an extended period (16-23 months). As well as providing an extensive data set on this subject, the data highlighted the importance of using accurate EM soil data for geophysical prospection. The greatest changes in geophysical properties for all sites were found in the near surface soils (< 0.5 m), where many buried utilities are found, with rapid wetting events and slower drying events greatly

affecting both the ARDP and BEC. However, the most critical factor for determining these properties was the soil water holding capacity which in turn was a function of the clay mineralogy and content. Analysis of the ratio of energy loss to storage showed that the optimum time for GPR surveying was found to be during dry periods and when the soil temperature was low, displaying the significance of soil temperature on survey outcomes due to its significant effect on BEC. The results from this paper will aid survey planning thereby ensuring better detection rates.

Keywords: seasonality, soil properties, time domain reflectometry, dielectric permittivity, electrical conductivity, electromagnetic performance, GPR performance

## Introduction

The performance of electromagnetic (EM) wave propagation methods of prospecting, such as ground penetrating radar (GPR), is heavily dependent on the geophysical properties of the soil, especially the apparent dielectric permittivity (ARDP) and bulk electrical conductivity (BEC). A greater understanding of the relationships involved is important for improving the performance of EM wave propagation techniques, and in particular GPR surveys, which has many applications for near surface geophysics, such as archaeological prospecting (Sciotti et al., 2003) and utility location (Thomas et al., 2007). Improving the performance of these techniques will increase their utilisation, as there will be greater confidence in the survey results and improved cost effectiveness. In addition, the number of undetected near-surface buried features is reduced, thereby significantly reducing the risk of excavation.

Several previous studies have shown links between the geophysical and geotechnical properties for soil including the soil particle size distribution (Gong, Cao and Sun, 2003; Ponizovsky, Chudinova and Pachepsky, 1999; Thring et al., 2014), density (Gong et al., 2003; Hipp, 1974; Malicki, Plagge and Roth, 1996), Atterberg limits and linear shrinkage (Thomas et al., 2010a; Thomas et al., 2010b), but by far the most important factor is the water content. These studies have primarily focused on testing the relationships in the laboratory over a range of volumetric water contents (VWC) and temperatures, but with limited seasonal variation, to determine the relationships between the apparent permittivity and water content (e.g. Bridge et al., 1996; Curtis, 2001; Thring et al., 2014; Topp, Davis and Annan, 1980). Whilst attempts have been made to characterise the suitability of different soils for GPR survey using basic soil

information (Doolittle and Collins, 1995; Doolittle et al., 2010; Doolittle et al., 2007) and monitor the water content of the soil on a site scale at a single point in time (Ferrara et al., 2013a; Ferrara et al., 2013b), significantly less attention has been given to the in-situ variation of the geophysical properties in a field environment due to changing climatic conditions. Curioni et al. (2012) showed that the ARDP and BEC vary seasonally and can be monitored using time domain reflectometry (TDR) in order to assess the performance of GPR, but efforts were limited to a single site at the University of Birmingham, UK. More extensive studies over a wider range of soils are crucially important to improve our knowledge of the seasonal effects on survey results. This paper addresses this significant knowledge gap by presenting extensive, high quality, long term monitoring data of soil EM properties using bespoke TDR monitoring stations for three different sites with widely variable geotechnical properties. These data are used to determine how seasonal variation affects the geophysical properties and subsequent behaviour of EM signals used by geophysical sensors such as GPR. This knowledge will allow better efficiency in geophysical survey planning and interpretation. With the most important factors for predicting the performance of geophysical sensors identified, existing data, for example using some available soil information and weather history data can be used to optimise the survey.

### **EM properties of soil and their effects on GPR**

Electromagnetic (EM) wave propagation survey methods, such as Ground penetrating radar (GPR) are among the most widely used tools for the detection of subsurface features in a range of fields including civil engineering, mineral exploration,

environmental management and archaeology (Conyers, 2004; Jol, 2009). However, the detection of subsurface features relies strongly on the transmission behaviour of the applied EM signal through the soil, and the ability to detect features is limited by several factors: the depth to which the signal can penetrate through an attenuating soil, and the resolving capability of the signal in terms of the size of targets which can be detected, which is determined by the signal wavelength. In addition, the velocity of the signal is important for determining the depth of buried targets, which is important for planning subsequent ground investigations and usually requires some estimation and which is dependent on the geophysical soil properties.

The transmission of EM radiation such as that used by GPR through soil is affected by three main factors; the relative electrical permittivity, relative magnetic permeability and electrical conductivity, with differences in these properties governing the overall velocity ( $v$ ; measured in m/s) and attenuation ( $\alpha$ ; measured in Np/m) of geophysical signals (Cassidy, 2009; Reynolds, 1997; Telford, Geldart and Sheriff, 1990). Knowledge of the wave velocity is useful for estimating the depth of buried features and the frequency dependent velocity of the signal can be calculated using equation 1 (Schneider and Fratta, 2009).

$$v(f) = \frac{c}{\sqrt{\frac{\mu\varepsilon'}{2} \left[ \sqrt{1 + \left( \frac{\varepsilon_p'' + \frac{\sigma}{\omega}}{\varepsilon'} \right)^2} + 1 \right]^{0.5}}}$$

[1]

Where  $c$  is the speed of light in free space ( $\approx 3 \times 10^8$  m/s),  $\mu$  is the magnetic permeability,  $\epsilon'$  is the real part of the electrical permittivity representing energy storage mechanisms,  $\epsilon_p''$  is the dipolar loss,  $\sigma$  is the DC conductivity and  $\omega$  is the angular frequency. Changes to the velocity also cause refraction of the signal and reduce the frequency and wavelength of the transmitted signal, affecting the resolution of the survey and the minimum size of features which can be detected, estimated at around 25% of the wavelength (Conyers, 2004). Another important factor is the attenuation constant (measured in Np/m), which describes the loss of the signal, thus restricting the depth at which targets can be detected which can be calculated using equation 2 (Thomas et al., 2007).

$$\alpha(f) = \omega \sqrt{\frac{\mu\epsilon'}{2}} \left( \sqrt{1 + \left( \frac{\epsilon_p'' + \frac{\sigma}{\omega}}{\epsilon'} \right)^2} - 1 \right)^{0.5}$$

[2]

Whilst the magnetic permeability is usually taken to be reasonably constant in time, the permittivity and conductivity are known to change with the soil properties, making the knowledge and prediction of their values important for survey planning. One way to measure these properties is using TDR, which transmits a short EM pulse into a coaxial transmission line that comprises a coaxial cable and a probe. The probe is generally made of two or three parallel metal rods inserted into the soil (Jones, Wraith and Or, 2002). The travel time of the reflected signal can be used to measure the soil's ARDP ( $\epsilon_a$ ) of the soil (Robinson et al., 2003; Topp et al., 1980) and the signal

attenuation is useful for determining the BEC (S/m) of the soil (Bechtold et al., 2010; Huisman et al., 2008). From the components that make up the soil (solid particles, air and water), water affects the geophysical properties the most, and hence the method has been widely used to measure the water content of the soil by converting the ARDP to volumetric water content using a variety of mixing models (e.g. Ledieu et al., 1986; Topp et al., 1980). These models have been widely reviewed (Mukhlisin and Saputra, 2013; Van Dam, Borchers and Hendrickx, 2005) and form the basis for many commercially available water content probes (e.g. IMKO GmbH, 2012).

In practice the method has some limitations; firstly, due to the broadband nature of the EM pulse (between a few tens of KHz and 2 GHz), the TDR effective measurement frequency is undefined and a function of the medium within which the pulse is travelling (i.e. lower in more “lossy” conductive mediums). To address these issues, several attempts have been made to define an effective measurement frequency at which the TDR operates. This is usually defined as either the highest passable frequency in the EM pulse (Lin, 2003; Robinson et al., 2003; Topp, Zegelin and White, 2000), the highest unfiltered frequency (Or and Rasmussen, 1999), or, more usually, the frequency in the pulse containing the most energy (Robinson et al., 2005), although it is generally considered to be similar to GPR (Chen and Or, 2006; Curioni et al., 2012; Huisman et al., 2003; Weiler et al., 1998) thus making the methods directly comparable. Testing of the TDR used in this study confirmed this assumption, with effective frequencies determined by the return reflections rise time of 300 – 500 MHz. Secondly, an assumption made using this method is that dielectric loss mechanisms are small in relation to the real energy storage part of the permittivity, and that the



magnetic effects are inconsequential in most soils (Robinson et al., 2003; Topp et al., 1980). However, these assumptions are violated in certain soils, especially those with high conductivities (Bittelli, Salvatorelli and Pisa, 2008; Jones and Or, 2004) and the magnetic properties have been shown to have a significant effect even in modestly magnetic soils (Cassidy, 2007). Nevertheless, the method possesses numerous advantages over other techniques for monitoring the seasonal properties as it is able to directly measure the same properties as the geophysical sensors. Furthermore, the ability to automate and multiplex measurements to collect data allows a high temporal and spatial resolution (Baker and Allmaras, 1990; Curioni et al., 2012; Evett, 1998; Evett, 2000) compared to traditional seasonality studies using repeat surveys.

## **Methodology**

### **Background**

The field (study) sites used in this research were chosen as part of the “Detection of Archaeological Residues using remote sensing Techniques” (DART) project (Research Councils UK, 2016), and involved different soil types and archaeological residues. Extensive bespoke monitoring stations were developed and located at each of the sites to allow continuous long term monitoring of the EM properties of the soils up to 1 m depth. This paper focuses on the data obtained from these monitoring stations, which are applicable to all prospection applications with EM wave propagation techniques, rather than the archaeological aspect of the project, which is covered elsewhere (Boddice, 2015; Boddice et al., 2013; Fry et al., 2012) and will be addressed in more detail in subsequent publications. This section describes the sites, the monitoring station design and installation and how the data collected were processed.

## **Study Sites**

Three sites were selected in the UK to represent a range of different soil types; two in Cambridgeshire (hereby designated site A and site B) on the East side of the country where the climate is typically warmer and drier, and one in Gloucestershire (site C) where the climate is notably wetter (Met Office, 2014). All sites consisted of three main soil layers, a topsoil layer and two subsoils (Figure 1).

One of the sites (site A) was predominantly made up of coarse grained soils while the other two were made of fine grained soils (sites B and C). Fine grained soils are known to cause the most difficulty during geophysical surveys. In order to characterise the soil on each site, suitable soil samples were taken for geotechnical testing, including undisturbed samples using monolith tins. Testing was carried out on each of the soils to determine their particle size distribution, particle and dry density, Atterberg limits and linear shrinkage according to methods outlined by BSI (1990). The results of this testing are provided in Table 1.

## **Monitoring station design and installation**

The monitoring stations used were constructed using the TDR100 system using two levels of SDMX50 multiplexers and CS645 75 mm probes (all manufactured by Campbell Scientific, Logan, Utah). The monitoring stations were based on the design of Curioni et al. (2012), who demonstrated a methodology for constructing and calibrating a TDR based monitoring station capable of long term data collection. However, due to the remote location of the sites, the netbook was replaced with a datalogger (CR1000; Campbell Scientific) using a compact flash card module to increase memory (CFM100; Campbell Scientific) and to reduce power consumption.

The monitoring station batteries were also connected to a 120W solar panel, which it was calculated using solar insolation figures to ensure that the system could operate remotely without the need to change the batteries on a weekly basis (Boxwell, 2010). Finally, in order to better understand the effects of thermal properties of the soil, 16 thermistor probes (T107; Campbell Scientific) were used (one for each TDR probe) and connected to the datalogger. A schematic of the new design is shown in Figure 2. The settings for controlling the TDR were configured to the same values as those described by Curioni et al (2012) as these were shown to give good results for long term field monitoring.

The calibration was carried out according to the methods stated by Curioni et al. (2012), To test the derived values, further testing was carried out. For the ARDP calibrations, the probes were tested using air, water at different temperatures and acetone which have known dielectric permittivity values and the BEC calibrations were tested using additional KCl solutions of different concentrations and a reference conductivity meter. Errors in ARDP determination (expressed as the difference between measured and reference values) were found to be < 2% for all the probes and the errors in BEC were <5% for all probes at the range of conductivity values found in most soils (<1 decisieman), which are similar to those found by Curioni, et al. (2012).

The installations were carried out in May 2011 (site C), June 2011 (site A) and August 2011 (site B), with the probes being buried at a number of depths on each site between 0.1-1m in vertical arrays. The monitoring stations were setup to take hourly readings of ARDP and BEC. Two of the sites (site B and site C) were monitored using a

16 probe array to provide duplicate data at each depth. This allowed for lateral variation and heterogeneity of the soil to be estimated, as well as providing some redundancy in case of probe failure during the monitoring period of the project. Analysis of the data from the duplicate probes showed good agreement throughout the monitoring period. In contrast, site A had a free draining soil and therefore was expected to be less geophysically complex and hence was monitored using an 8 probe array. Each site was also fitted with a weather station (Vantage Pro2; Davis instruments) to record precipitation, air temperature, wind speed and direction, humidity and pressure, and to estimate evapotranspiration (ET) in order to correlate the measured values to climatic conditions.

There were some initial stability issues with the monitoring stations, with regular gaps in data, seen in subsequent plots towards the start of the monitoring period. This was solved by using a different brand of CF cards and reducing the data collection rate.

### **Data Processing**

Due to the volume of data being collected, it was deemed necessary to automate the analysis of waveforms collected by the monitoring stations. A series of functions written in a commercial software package (MATLAB; MathWorks Inc.) to deal with the large datasets were developed to analyse both ARDP and BEC type waveforms. Further details of the mathematical processes used can be found in Curioni et al. (2012). Due to the nature of the interpretation process and its reliance on fitting tangents to noisy measured waveforms using mathematical processes, uncertainty and errors can occur in determining the measured values. In order to test this, extensive testing was conducted over a wide range of waveforms (approximately 1000),

including extreme values. The results showed minimal uncertainty, not exceeding 0.21 permittivity units. The use of an automated fitting algorithm was therefore not thought to be noticeably detrimental to the quality of the data acquired. Further quality control was carried out throughout the project to examine waveforms of outlying and unusual values and identify possible issues arising from the interpretation method.

## **Results and Discussion**

In order to produce clearer plots, data from probes at similar depths and in the same soils have been averaged over 24 hour periods to give daily values for ARDP and BEC at a range of depths. The rainfall and ET data have also been provided as cumulative values to give the water balance over 24 hour periods. Figures 3 and 4 show ARDP and BEC data at a number of different depths, together with the cumulative water balance for all three sites during the whole monitoring period.

All of the soils showed an expected strong dependence on rainfall and ET in determining their geophysical properties, especially in the near surface. This is not surprising given the dependence of soil EM properties to water content, and the results are similar to those recorded during long term monitoring by other authors (e.g. Curioni et al., 2012; Menziani et al., 2003). The monitoring period was characterised by an unusually dry summer and winter period in 2011 and an extremely wet year from spring 2012 onwards, which it is believed has affected typical seasonal variation. This is reflected in the ARDP data (Figure 3), which for all sites show low ARDP values at the start of the monitoring period in 2011 prior to a wetting front in

early 2012, although an additional period of low ARDP values during September and October 2012 is noticeable in the surface soils (depth < 0.2 m) on site B following drying during the summer which caused the topsoil on the site to desaturate. It is interesting to note that few periods were found with intermediate values between these extremes, suggesting the soil exists in either a dry state after extensive periods of drying or in a saturated state. Other authors (Brunet, Clément and Bouvier, 2010; Scollar et al., 1990) have highlighted a period of water content stability between autumn and spring followed by a period of drying over the summer (June-August) until early autumn, when rain caused the soil to re-saturate to field capacity. Whilst the timescale of the dry and wet periods do not agree in the current study, it is likely that the unusual weather patterns over the monitoring period will have affected the typical seasonal variation. On site A (Figure 3a) where the monitoring period extended slightly later, towards the end of 2012 a third period was noticed, consisting of a large rise in the ARDP at greater depths (0.6m - 1.2m), which seemed to unusually affect the bottom layers first, contradicting the usual models of infiltration after rainfall. One suggestion for this may be that this was caused by a rise in the water table. Excavations carried out during the removal of the sensor in June 2013 suggest that the water table was indeed high during this period as it was located in the bottom of the trench (c. 1.2m depth). Much of the subsequent data were very noisy and fluctuating, possibly due the water table fluctuating during this period although it is more likely that this shows an equipment malfunction.

The measured BEC values on all of the sites (Figure 4) showed similar trends to the measured ARDP on all the sites, with rises after rainfall events and falls after periods of

drying. This is not surprising as it has been shown that the BEC of soil is principally determined by its water content (Smith-Rose, 1933; Thring et al., 2014), due to the increase in ions present in the rainwater and dissolved from the soil which create a greater number of conductive pathways. However, although the changing water content was responsible for the largest changes in BEC, on all the sites the BEC showed additional variations in measured values which were not apparent in the ARDP data, corresponding to rises and falls in the soil temperature (shown in Figure 5) during similar periods. This is in agreement with the findings of other authors who show the dependence of BEC on temperature (Campbell, Bower and Richards, 1948; Friedman, 2005). It should also be noted that these variations were greater during the wet period due to the presence of additional dissolved ions.

For all of the studied soils, changes with rainfall primarily affected the topsoil and subsoils down to c. 0.3-0.5 m, with changes in the deeper soils occurring relatively infrequently and only after heavy rain following a period of extensive drying on the surface. This agrees with hydrological theory, which suggests that surface effects are dominant on infiltration capacity and therefore drying increases infiltration as the soil shrinks and pores are reopened (Beven, 2004; Horton, 1933). Interestingly, the values of ARDP and BEC (Figures 3 and 4) taken from the shallower depth probes did not decrease as values from the soil layers below increased and the effects of rainfall on ARDP values at depth occurred within the same day suggesting an instant infiltration. These observations can also be seen in data from other studies (e.g. Menziani et al., 2003) and suggest that the same water was not travelling down the profile, supporting the piston-like displacement of stored water infiltration theory (Hewlett and Hibbert,

1967; Horton and Hawkins, 1965) as opposed to the flow through unsaturated pores. Whilst this behaviour is expected for fine grained soils (Youngs and Poulouvasilis, 1976), on the coarser grained site A (Figures 3a and 4a) this is an unusual result. One possibility is that as infiltration is largely controlled by the surface soil properties as highlighted above, the comparatively finer grained materials in the topsoil and upper subsoil have influenced the result. In contrast to the speed of infiltration, drying events during warm periods where evapotranspiration exceeded rainfall (shown as negative values on the bar charts) occurred at a much slower rate, requiring several days of dry weather before significant changes were observed on all of the measured soils. This is shown in greater detail in Figure 6. This has also been observed in the data of other authors (Curioni et al., 2012; Menziani et al., 2003) and is due to the fact water can enter soil pores easier than it can escape due to surface tension (Haines, 1930). As a result of this, the coarse grained site A soils with their smaller surface areas and holding potential dry at a faster rate and to greater depths than either of the other two clay dominated sites. This is shown by the steeper downward limbs in Figures 3a and 4a occurring during periods of dry weather. Knight (1991) has also noted hysteresis in conductivity due to variation in the fluid distribution in the pores due to imbibition and drainage after multiple wetting and drying cycles. As conductivity is highly dependent on pore geometry whereas ARDP is less dependent at the measurement frequencies used. To investigate this, ARDP and BEC data has been divided up into periods of wetting and drying and plotted against each other. Data are shown in Figure 7. No obvious differences between the wetting and drying cycles were evident due to pore water distribution, although this may be because the effects of



temperature on BEC are much larger, dwarfing the effects of pore water distribution. Significant differences existed in the measured geophysical values on different soil types, with higher values of both ARDP and BEC recorded on the finer grained soils (sites B; Figures 3b and 4b and C; Figures 3c and 4c) throughout the monitoring period compared with the coarse grained soils on site A (Figures 3a and 4a). This is perhaps not surprising as laboratory testing on similar soils has shown the behaviour of both values with variation in water content to be linked to the clay content and specific surface area of the soils (Thomas et al., 2010a; Thomas et al., 2010b; Thring et al., 2014). However, as the values on the fine grained soils were typically up to double those of site A, it is almost certain that fine grained sites also had greater water contents as differences in published ARDP-BEC-VWC relationships between different soils (Thring et al., 2014) are not large enough to explain a difference of this magnitude. This result is not surprising as clay soils are known to have higher soil water potentials due to their greater surface areas (Fredlund and Xing, 1994; Rawls, Brackensiek and Saxton, 1982), and it is suggested that the higher values on fine grained soils are mainly the result of higher water contents, with differences in relationships between VWC and geophysical properties playing a more minor role.

In order to assess which geotechnical properties were most important for determining the seasonal variability, a multi-variate statistical analysis using principal component analysis (PCA) was used with the geophysical properties (ARDP, BEC and magnetic permeability), temperature and geotechnical properties (particle size distributions, Atterberg limits, particle and dry density, total porosity, linear shrinkage and loss on ignition). PCA consists of a mathematical procedure used to reduce the complexity of

datasets consisting of multiple correlated variables by rotating the data to a new co-ordinate system, determined by uncorrelated variables (known as principal components) which account for a proportion of the total data variance (Jolliffe, 2002). The percentage variation accounted for by each new principal component is displayed in the scree plot (Figure 8a), which shows that around 80% of the measured variation expressed just using the first two principal components. A typical output of the PCA is the biplot (Figure 8b), which displays the samples as points and the variables as vectors with respect to a new co-ordinate system and can be used to assess the correlation between different variables. The EM properties showed good correlation (positioned near to each other on the biplot) both with each other as well as with the clay percentage and the plastic and liquid limits of the soil, making these the most important factors for determining the soil's EM properties. This reflects its mineralogy and specific surface area, and indicates that the average water content of soils was strongly determined by the clay content and mineralogy over the monitoring period. This supports the idea that the primary difference in geophysical behaviour is a function of the ability of a soil to hold water, as these variables affect the specific surface area of the soil which in turn determines the soil suction potential. It should also be noted that data from probes located in the same soil types displayed similar behaviour shown by the clustering of these points into small groups, thus confirming the dependence of the geophysical properties on the geotechnical soil properties.

## Impact of Observed Seasonal Behaviour on Geophysical Survey Performance

Using a GPR is a balance between having sufficient resolution to detect the features of interest (best facilitated by high frequency antenna with short wavelengths), while retaining sufficient depth of penetration to reach them (which improves with lower frequencies due to the frequency dependence of EM attenuation). Soils where the loss tangent is low ( $< 0.1$ ) are considered to be low loss whereas soils with high loss tangents ( $> 0.1$ ) are termed dispersive, as they attenuate the signal faster, and shift the radar pulse's amplitude spectrum to lower frequencies, reducing resolution. Since the ARDP measured with TDR is done using the travel time of EM pulses of broadly similar frequency to GPR, and the BEC measured using the loss of the applied signal, this can be treated as broadly similar to the wave velocity and attenuation expected in different soil conditions respectively. As expected, GPR waves penetrate better and travel faster in dry conditions; i.e. when the two values are at a minimum. It is also important to account for changes in the wave velocity if accurate target depths are needed, as they differ significantly through the year. Another way to assess the performance of GPR is to take the ARDP to be indicative of energy storage mechanisms (i.e.  $ARDP \approx \epsilon'$  as is commonly assumed in TDR (e.g. Topp et al., 1980) and the BEC to be indicative of the loss mechanisms, as the majority of losses in wet soil are conductive and measured dielectric losses have been shown to be proportional to BEC (Topp et al., 2000). In this instance, GPR could be said to work best when the ratio between loss and storage was at a minimum. Assuming that  $ARDP \approx \epsilon'$  and the dielectric losses are proportional to the BEC as suggested by Topp et al. (2000), approximations of the loss tangents for the studied soils were calculated using Equation 3.

$$\tan \delta = \frac{\sigma_{DC}}{\omega \epsilon_a \epsilon_0}$$

[3]

Where  $\sigma_{DC}$  is the measured BEC,  $\epsilon_a$  is the measured ARDP,  $\epsilon_0$  is the permittivity of free space and  $\omega$  is the angular frequency, calculated from the rise time of the returning reflection for the ARDP waveforms using the method suggested by other authors (Robinson et al., 2005; Topp et al., 2000). The results are shown in Figure 9, where it can be seen that the loss tangents are consistently higher for the sites with fine grained soils on sites, with site B providing the highest values throughout the study period. The optimum time for surveying appears to be between February and March 2012. The reasons for this are twofold: firstly, this period comes after the long dry period experienced in 2011 and secondly this comes at the point where temperature is at a minimum on all the sites, leading to decreased BEC values. Interestingly, during the wet period, especially at greater depths (> 0.5 m), the ARDP remained fairly constant, but the loss tangent continues to increase due to rising BEC. Importantly, since both ARDP and BEC follow similar trends with water content change, soil temperature may be the most important factor in determining these values, indicated by the strong tendency of the graph to follow the soil temperature trends shown in Figure 5.

## Conclusions

Extensive long term monitoring of the key EM properties which affect the performance of GPR was conducted over three sites with different soil properties using bespoke TDR monitoring stations at a high temporal and spatial resolution. The key findings and conclusions from this research are:

- The high spatial and temporal resolution of the data provided unique insight into the seasonal variability of the geophysical soil properties, filling a gap in the literature to aid the understanding of how EM travel time techniques are affected. Across all of the studied soils, analysis of the data showed that the ARDP for all the sites was strongly correlated with the rainfall, and the BEC correlated with a combination of rainfall and soil temperature which varied throughout the data collection period. However, on all three sites, infiltration events only affected deeper soils (c. > 0.5 m) after several days of dry weather had caused drying on the surface. Interestingly, infiltration was very rapid after rainfall, even on the fine grained soil sites and was shown on all sites to be predicated by a piston-like method of water redistribution as the surface layers did not desaturate. In contrast, drying was a more gradual process taking several days of dry weather to decrease the measured values, but occurred at a greater rate and to a greater depth on coarse grained soils.
- Although the behaviour of the different soils in response to rainfall events was similar, large differences existed in the absolute values, with fine grained soils displaying greater values for ARDP and BEC throughout the survey period, which were the result in different volumetric water contents.
- It can be concluded that the soil moisture holding capacity is the most important factor for determining the seasonal geophysical behaviour of field soils, which has been shown to be a function of the surface area of the soil. The optimum time for GPR signal penetration on all soils was found to be in dry conditions and when the temperature was at a minimum, which occurred in

early 2012, following one of the driest winters on record, although the optimisation of surveying was more critical on fine grained soils where the loss tangents were higher.

- These findings are important as they show the interaction between weather histories and soil properties, which is instructive for predicting the performance of GPR surveys using some knowledge of the soil properties and weather data obtainable from accessible databases. This is of great benefit both for survey planning in terms of time and sensor configuration (e.g. choice of antenna frequency), and for the processing and interpretation of the depth of targets based on the use of an average ARDP value, thus increasing the efficiency of geophysical surveys conducted with EM travel time methods.

## **Acknowledgements**

The authors acknowledge the financial support provided by the UK's Arts and Humanities Research Council (AHRC) and Engineering and Physical Sciences Research Council (EPSRC) through the "Detection of Archaeological Residues using remote sensing Techniques" (DART) project AH/H032673/1. Data used as part of the project is available under an Open Data Commons Attribution License from <https://dartportal.leeds.ac.uk/>

## References

Baker, J.M. and Allmaras, R.R. 1990. System for Automating and Multiplexing Soil-Moisture Measurement by Time-Domain Reflectometry. *Soil Science Society of America Journal* 54, 1-6

Bechtold, M., Huisman, J.A., Weihermueller, L. and Vereecken, H. 2010. Accurate Determination of the Bulk Electrical Conductivity with the TDR100 Cable Tester. *Soil Science Society of America Journal* 74, 495-501

Beven, K. 2004. Robert E. Horton's Perceptual Model of Infiltration Processes. *Hydrological Processes* 18, 3447-3460

Bittelli, M., Salvatorelli, F. and Pisa, P.R. 2008. Correction of TDR-Based Soil Water Content Measurements in Conductive Soils. *Geoderma* 143, 133-142

Boddice, D. 2015. *Changing geophysical contrast between archaeological features and surrounding soil*. Ph.D. University of Birmingham.

Boddice, D., Fry, R., Beck, A.R., Gaffney, C., Metje, N. and Schmidt, A. 2013. The Impact of Environmental Dynamics on Multiple Sensor Responses over Archaeological Features, Examples from the DART Project. In: *Archaeological Prospection: Proceedings of the 10th International Conference Vienna* (eds. W. Neubauer, I. Trinks, R.B. Salisbury and C. Einwögerer), pp. 415-418. Austrian Academy of Sciences Press.

Boxwell, M. 2010. *Solar Electricity Handbook 2010: A Simple Practical Guide to Solar Energy - Designing and Installing Photovoltaic Solar Electric Systems*. Code Green Publishing, Ryton-on-Dunsmore.

Bridge, B.J., Sabburg, J., Habash, K.O., Ball, J.A.R. and Hancock, N.H. 1996. The Dielectric Behaviour of Clay Soils and its Application to Time Domain Reflectometry. *Australian Journal of Soil Research* 34, 825-835

Brunet, P., Clément, R. and Bouvier, C. 2010. Monitoring Soil Water Content and Deficit Using Electrical Resistivity Tomography (ERT) – A Case Study in the Cevennes Area, France. *Journal of Hydrology* 380, 146-153

BSI 1990. Methods of Test for Soils for Civil Engineering Purposes: Part 2: Classification Tests. In: *Methods of Test for Soils for Civil Engineering Purposes: Part 2: Classification Tests*. British Standards Institution.

Campbell, R.B., Bower, C.A. and Richards, L.A. 1948. Change of Electrical Conductivity with Temperature and the Relation of Osmotic Pressure to Electrical Conductivity and Ion Concentration for Soil Extracts. *Soil Science Society Proceedings*, 66-69

Cassidy, N.J. 2007. Frequency-Dependent Attenuation and Velocity Characteristics of Magnetically Lossy Materials. IEEE Proceedings of the 4th International Workshop on Advanced Ground Penetrating Radar, Naples, Italy, 142-146.

Cassidy, N.J. 2009. Electrical and Magnetic Properties of Rocks, Soils and Fluids. In: *Ground-Penetrating Radar: Theory and Applications* (ed. H.M. Jol), pp. 41-72. Elsevier Science.

Chen, Y. and Or, D. 2006. Effects of Maxwell-Wagner Polarization on Soil Complex Dielectric Permittivity Under Variable Temperature and Electrical Conductivity. *Water Resources Research* 42, W06424

Conyers, L.B. 2004. *Ground-Penetrating Radar for Archaeology*. AltaMira Press, Lanham.

Curioni, G., Chapman, D.N., Metje, N., Foo, K.Y. and Cross, J.D. 2012. Construction and Calibration of a Field TDR Monitoring Station. *Near Surface Geophysics* 10, 249-261

Curtis, J.O. 2001. Moisture Effects on the Dielectric Properties of Soils. *IEEE Transactions on Geoscience and Remote Sensing* 39, 125-128

Doolittle, J.A. and Collins, M.E. 1995. Use of Soil Information to Determine Application of Ground-Penetrating Radar. *Journal of Applied Geophysics* 33, 101-108

Doolittle, J.A., Dobos, R., Peaslee, S.D., Waltman, S.W., Benham, E.C. and Tuttle, W. 2010. Revised Ground-Penetrating Radar Soil Suitability Maps. *Journal of Environmental and Engineering Geophysics* 15, 111-118

Doolittle, J.A., Minzenmayer, F.E., Waltman, S.W., Benham, E.C., Tuttle, J.W. and Peaslee, S.D. 2007. Ground-Penetrating Radar Soil Suitability Map of the Conterminous United States. *Geoderma* 141, 416-421

Evet, S.R. 1998. Coaxial Multiplexer for Time Domain Reflectometry Measurement of Soil Water Content and Bulk Electrical Conductivity. *Transactions of American Society of Agricultural Engineers* 41, 361-369

Evet, S.R. 2000. The TACQ Computer Program for Automatic Time Domain Reflectometry Measurements: I. Design and Operating Characteristics. *Transactions of American Society of Agricultural Engineers* 43, 1939-1946



- Ferrara, C., Barone, P.M., Steelman, C.M., Pettinelli, E. and Endres, A.L. 2013a. Monitoring Shallow Soil Water Content Under Natural Field Conditions Using the Early-Time GPR Signal Technique. *Vadose Zone Journal* 12
- Ferrara, C., Di Tullio, V., Barone, P.M., Mattei, E., Lauro, S.E., Proietti, N., Capitani, D. and Pettinelli, E. 2013b. Comparison of GPR and unilateral NMR for water content measurements in a laboratory scale experiment. *Near Surface Geophysics* 11, 143-153
- Fredlund, D.G. and Xing, A.Q. 1994. Equations for the Soil-Water Characteristic Curve. *Canadian Geotechnical Journal* 31, 521-532
- Friedman, S.P. 2005. Soil Properties Influencing Apparent Electrical Conductivity: A Review. *Computers and Electronics in Agriculture* 46, 45-70
- Fry, R., Stott, D., Boddice, D. and Beck, A.R. 2012. What a Difference a Year Makes: Preliminary DART Datasets from Cherry Copse, Cirencester. *AARG News* 45, 42-47
- Gong, Y., Cao, Q. and Sun, Z. 2003. The Effects of Soil Bulk Density, Clay Content and Temperature on Soil Water Content Measurement Using Time-Domain Reflectometry. *Hydrological Processes* 17, 3601-3614
- Haines, W.B. 1930. Studies in the Physical Properties of Soil V: The Hysteresis Effect in Capillary Properties, and the Modes of Moisture Distribution Associated Therewith. *Journal of Agricultural Science* 20, 97-116
- Hewlett, J.D. and Hibbert, A.R. 1967. Factors Affecting the Response of Small Watersheds to Precipitation in Humid Areas. In: *Forest Hydrology* (eds. W.E. Sopper and H.W. Lull), pp. 275-290. Pergamon Press.
- Hipp, J.E. 1974. Soil Electromagnetic Parameters as Functions of Frequency, Soil Density, and Soil Moisture. *Proceedings of the IEEE* 62, 98-103
- Horton, J.H. and Hawkins, R.H. 1965. Flow Path of Rain from the Soil Surface to the Water Table. *Soil Science* 100, 377-383
- Horton, R.E. 1933. The Role of Infiltration in the Hydrologic Cycle. *Transactions of the American Geophysical Union* 14, 446-460
- Huisman, J.A., Lin, C.P., Weihermüller, L. and Vereecken, H. 2008. Accuracy of Bulk Electrical Conductivity Measurements with Time Domain Reflectometry. *Vadose Zone Journal* 7, 426

Huisman, J.A., Snepvangers, J.J.J.C., Bouten, W. and Heuvelink, G.B.M. 2003. Monitoring Temporal Development of Spatial Soil Water Content Variation: Comparison of Ground Penetrating Radar and Time Domain Reflectometry. *Vadose Zone Journal* 2, 519-529

IMKO GmbH 2012. *IMKO GmbH Trime System Specifications*. IMKO GmbH, Ettlingen, Germany.

Jol, H. 2009. *Ground Penetrating Radar: Theory and Applications*. Elsevier Science, Amsterdam.

Jolliffe, I.T. 2002. *Principal Component Analysis*. Springer-Verlag, Secaucus, NJ.

Jones, S.B. and Or, D. 2004. Frequency Domain Analysis for Extending Time Domain Reflectometry Water Content Measurement in Highly Saline Soils. *Soil Science Society of America Journal* 68, 1568-1577

Jones, S.B., Wraith, J.M. and Or, D. 2002. Time domain reflectometry measurement principles and applications. *Hydrological Processes* 16, 141-153

Knight, R. 1991. Hysteresis in the electrical resistivity of partially saturated sandstones *Geophysics* 56, 2139-2147

Ledieu, J., De Ridder, P., De Clerck, P. and Dautrebande, S. 1986. A Method of Measuring Soil Moisture by Time Domain Reflectometry. *Journal of Hydrology* 88, 319-328

Lin, C.P. 2003. Frequency Domain Versus Travel Time Analysis of TDR Waveforms for Soil Moisture Measurements. *Soil Science Society of America Journal* 67, 720-729

Malicki, M.A., Plagge, R. and Roth, C.H. 1996. Improving the Calibration of Dielectric TDR Soil Moisture Determination taking into Account the Solid Soil. *European Journal of Soil Science* 47, 357-366

Menziani, M., Pugnaghi, S., Vincenzi, S. and Santangelo, R. 2003. Soil Moisture Monitoring in the Toce Valley (Italy). *Hydrology and Earth System Sciences* 7, 890-902

Met Office. 2014. *Regional Climate Summaries*. [Online] [cited 09/04/16]; Available from: <http://www.metoffice.gov.uk/climate/uk/regional/>.

Mukhlisin, M. and Saputra, A. 2013. Performance Evaluation of Volumetric Water Content and Relative Permittivity Models. *The Scientific World Journal* 2013, 421762

Or, D. and Rasmussen, V.P. 1999. Effective frequency of TDR travel time based measurement of bulk dielectric permittivity. Third Workshop on Electromagnetic Wave Interaction With Water and Moist Substances, Russell Agric. Res. Cent, Athens.

Ponizovsky, A.A., Chudinova, S.M. and Pachepsky, Y.A. 1999. Performance of TDR Calibration Models as Affected by Soil Texture. *Journal of Hydrology* 218, 35-43

Rawls, W.J., Brackensiek, D.L. and Saxton, K.E. 1982. Estimation of Soil Water Properties. *Transactions of American Society of Agricultural Engineers* 25, 1316-1328

Research Councils UK. 2016. *Gateway to Research: The Detection of Archaeological residues using Remote Sensing Techniques (DART)*. [Online] [cited 26/05/16]; Available from: <http://gtr.rcuk.ac.uk/projects?ref=AH/H032673/1>.

Reynolds, J.M. 1997. *An Introduction to Applied and Environmental Geophysics*. John Wiley & Sons, Chichester.

Robinson, D.A., Jones, S.B., Wraith, J.M., Or, D. and Friedman, S.P. 2003. A Review of Advances in Dielectric and Electrical Conductivity Measurement in Soils Using Time Domain Reflectometry. *Vadose Zone Journal* 2, 444-475

Robinson, D.A., Schaap, M.G., Or, D. and Jones, S.B. 2005. On the Effective Measurement Frequency of Time Domain Reflectometry in Dispersive and Non-Conductive Dielectric Materials. *Water Resources Research* 41, W02007

Schneider, J.M. and Fratta, D. 2009. Time-Domain Reflectometry - Parametric Study for the Evaluation of Physical Properties in Soils. *Canadian Geotechnical Journal* 46, 753-767

Sciotti, M., Colone, F., Pastina, D. and Bucciarelli, T. 2003. GPR for Archaeological Investigations: Real Performance Assessment for Different Surface and Subsurface Conditions. *IEEE International Geoscience and Remote Sensing Symposium Proceedings: Learning from Earth's Shapes and Sizes*, Toulouse, France, 2266-2268.

Scollar, I., Tabbagh, A., Hesse, A. and Herzog, I. 1990. *Archaeological Prospecting and Remote Sensing*. Cambridge University Press, Cambridge.

Smith-Rose, R.L. 1933. The Electrical Properties of Soils for Alternating Currents at Radio Frequencies. *Proceedings of the Royal Society of London* 140, 359

Telford, W.M., Geldart, L.P. and Sheriff, R.E. 1990. *Applied Geophysics*. Cambridge University Press, Cambridge.

Thomas, A.M., Chapman, D.N., Rogers, C.D.F. and Metje, N. 2010a. Electromagnetic Properties of the Ground: Part I – Fine-Grained Soils at the Liquid Limit. *Tunnelling and Underground Space Technology* 25, 714-722

Thomas, A.M., Chapman, D.N., Rogers, C.D.F. and Metje, N. 2010b. Electromagnetic Properties of the Ground: Part II – The Properties of Two Selected Fine-Grained Soils. *Tunnelling and Underground Space Technology* 25, 714-722

Thomas, A.M., Rogers, C.D.F., Metje, N. and Chapman, D.N. 2007. Soil Electromagnetic Mapping for Enhanced GPR Utility Location. *Proceedings of the 25th International Conference on Trenchless Installation of Utilities, No-Dig 2007, Rome, Italy.*

Thring, L., Boddice, D., Metje, N., Curioni, G., Chapman, D. and Pring, L. 2014. Factors Affecting Soil Permittivity and Applications in Soil Mechanics. *Canadian Geotechnical Journal* 51, 1303-1317

Topp, G.C., Davis, J.L. and Annan, A.P. 1980. Electromagnetic Determination of Soil-Water Content - Measurements in Coaxial Transmission Lines. *Water Resources Research* 16, 574-582

Topp, G.C., Zegelin, S.J. and White, I. 2000. Impacts of the Real and Imaginary Components of Relative Permittivity on Time Domain Reflectometry Measurements in Soils. *Soil Science Society of America Journal* 64, 1244-1252

Van Dam, R.L., Borchers, B. and Hendrickx, J.M.H. 2005. Methods for Prediction of Soil Dielectric Properties: A Review. *Proceedings of the Society of Photo-Optical Instrumentation Engineers* 5794, 188-197

Weiler, K.W., Steenhuis, T.S., Boll, J. and Kung, K.J.S. 1998. Comparison of Ground Penetrating Radar and Time-Domain Reflectometry as Soil Water Sensors. *Soil Science Society of America Journal* 62, 1237-1239

Youngs, E.G. and Poulouvalis, A. 1976. The Different Forms of Moisture Profile Development During the Redistribution of Soil Water After Infiltration. *Water Resources Research* 12, 1007-1012

## Tables

**Table 1: The geotechnical properties of the soils on each of the studied sites**

Site	Soil Name	Particle Size				Particle Density g/cm <sup>3</sup>	Dry Density g/cm <sup>3</sup>	Atterberg Limits		Linear Shrinkage %
		Gravel	Sand	Silt	Clay			Plastic Limit	Liquid Limit	
		%	%	%	%			-	-	
<b>A</b>	Topsoil	8.1	39.2	39.0	13.7	2.60	1.62	17	30	8.3
	Upper Subsoil	11.3	33.5	41.1	14.0	2.65	1.66	15	25	8.4
	Lower Subsoil	33.3	47.4	13.3	6.0	2.69	✖	16	26	6.8
<b>B</b>	Topsoil	6.3	22.0	49.8	21.9	2.58	1.56	22	48	15.2
	Upper Subsoil	6.9	20.0	45.6	27.4	2.62	1.66	21	47	13.7
	Lower Subsoil	6.5	16.3	46.3	30.9	2.83	1.90	18	40	10.5
<b>C</b>	Topsoil	5.0	17.3	39.7	38.1	2.65	1.63	26	53	18.5
	Upper Subsoil	1.6	18.7	33.9	45.8	2.73	1.64	20	56	18
	Lower Subsoil	12.4	18.6	35.4	29.8	2.73	1.78	21	47	15

✖ Undisturbed sample was not available as the soil was not cohesive enough

## Figure Captions

Figure 1: The soil profiles for a) site A b) site B and c) site C

Figure 2: Schematic showing the setup of the TDR monitoring stations used on each site

Figure 3: ARDP and net rainfall over the study period at a range of depths for a) site A b) site B and c) site C

Figure 4: BEC and net rainfall over the study period at a range of depths for a) site A b) site B and c) site C

Figure 5: Daily averages of soil temperature over the study period at a range of depths for a) site A b) site B and c) site C

Figure 6: Principal component analysis (PCA) using the measured soil properties and average values for ARDP and BEC over the monitoring period featuring a) Scree plot b) Biplot output

Figure 7: The ratio between the average BEC and average ARDP for the three sites over the study period

## Figures

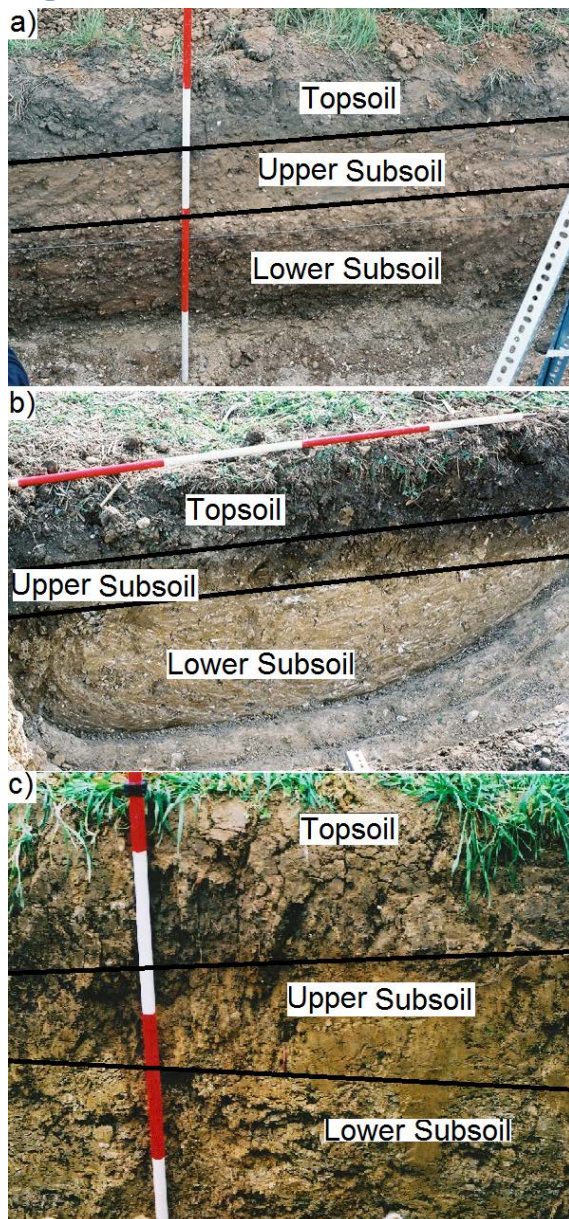

Figure 1: The soil profiles for a) site A b) site B and c) site C

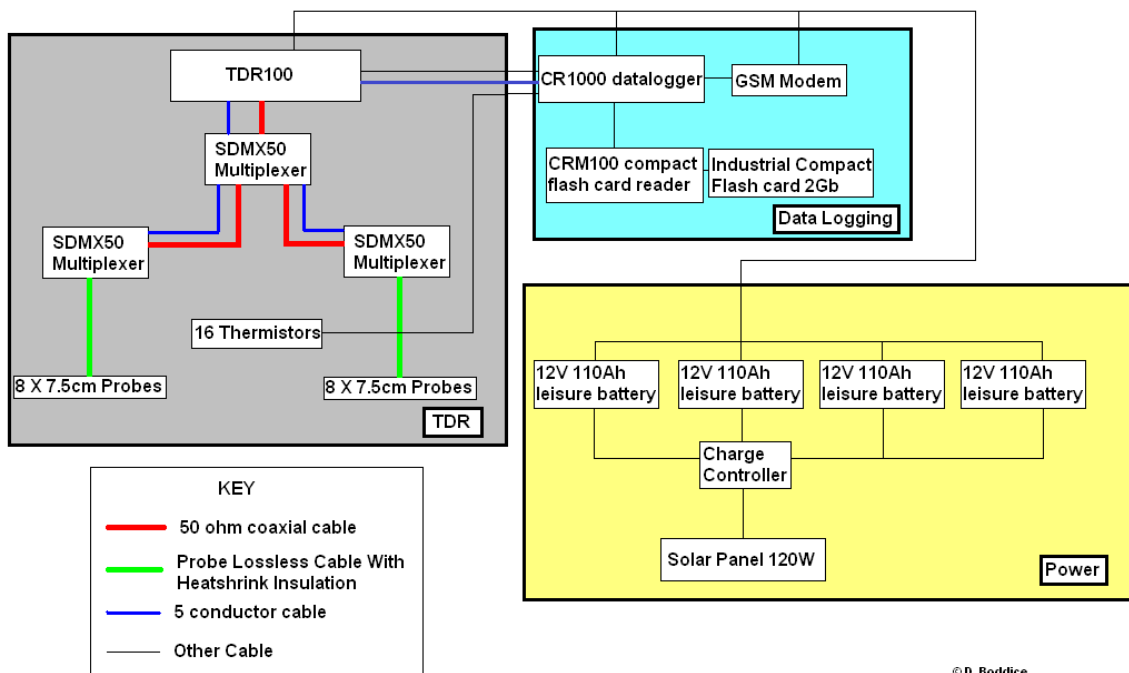

Figure 2: Schematic showing the setup of the TDR monitoring stations used on each site



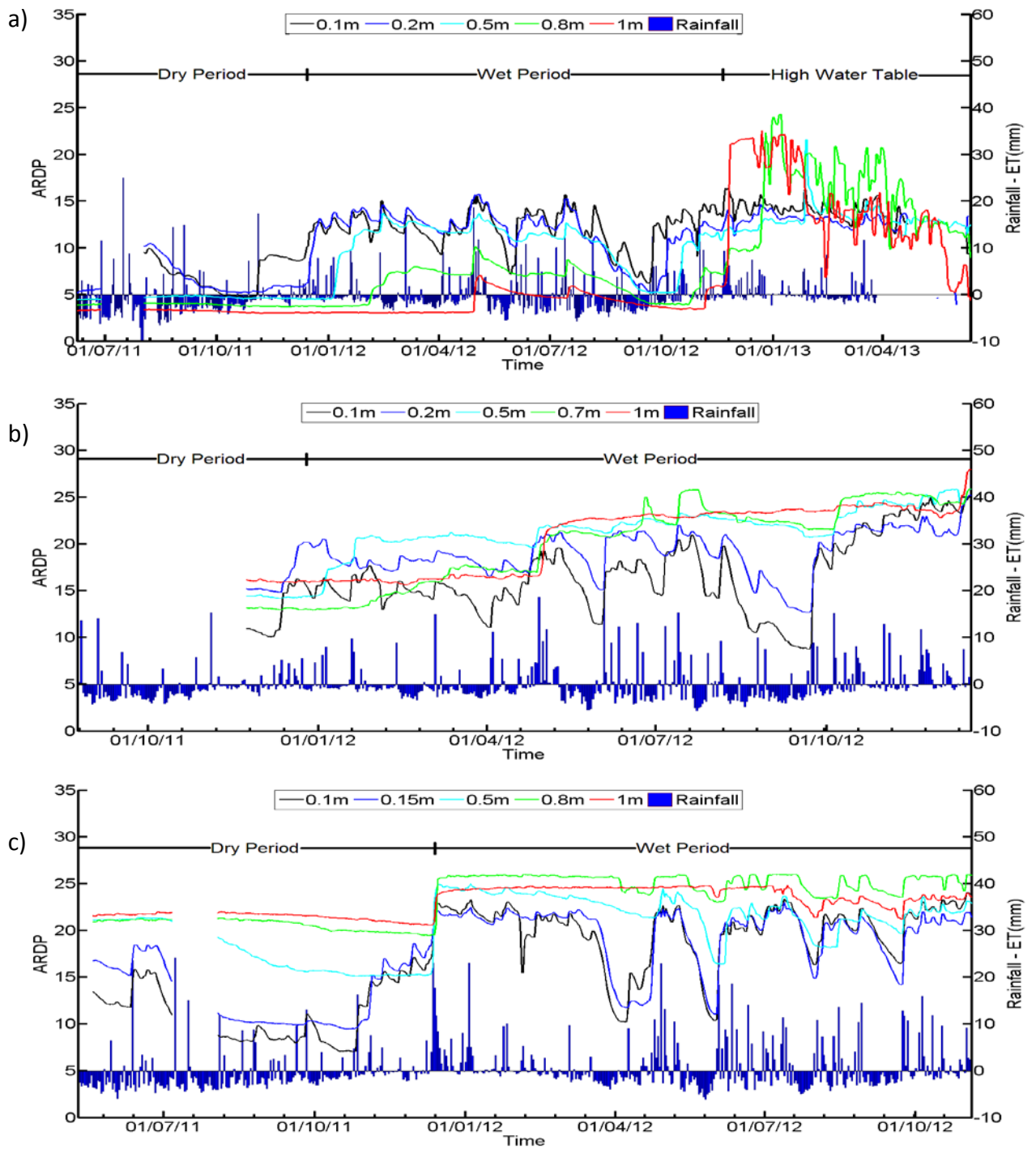

Figure 3: ARDP and net rainfall over the study period at a range of depths for a) site A b) site B and c) site C

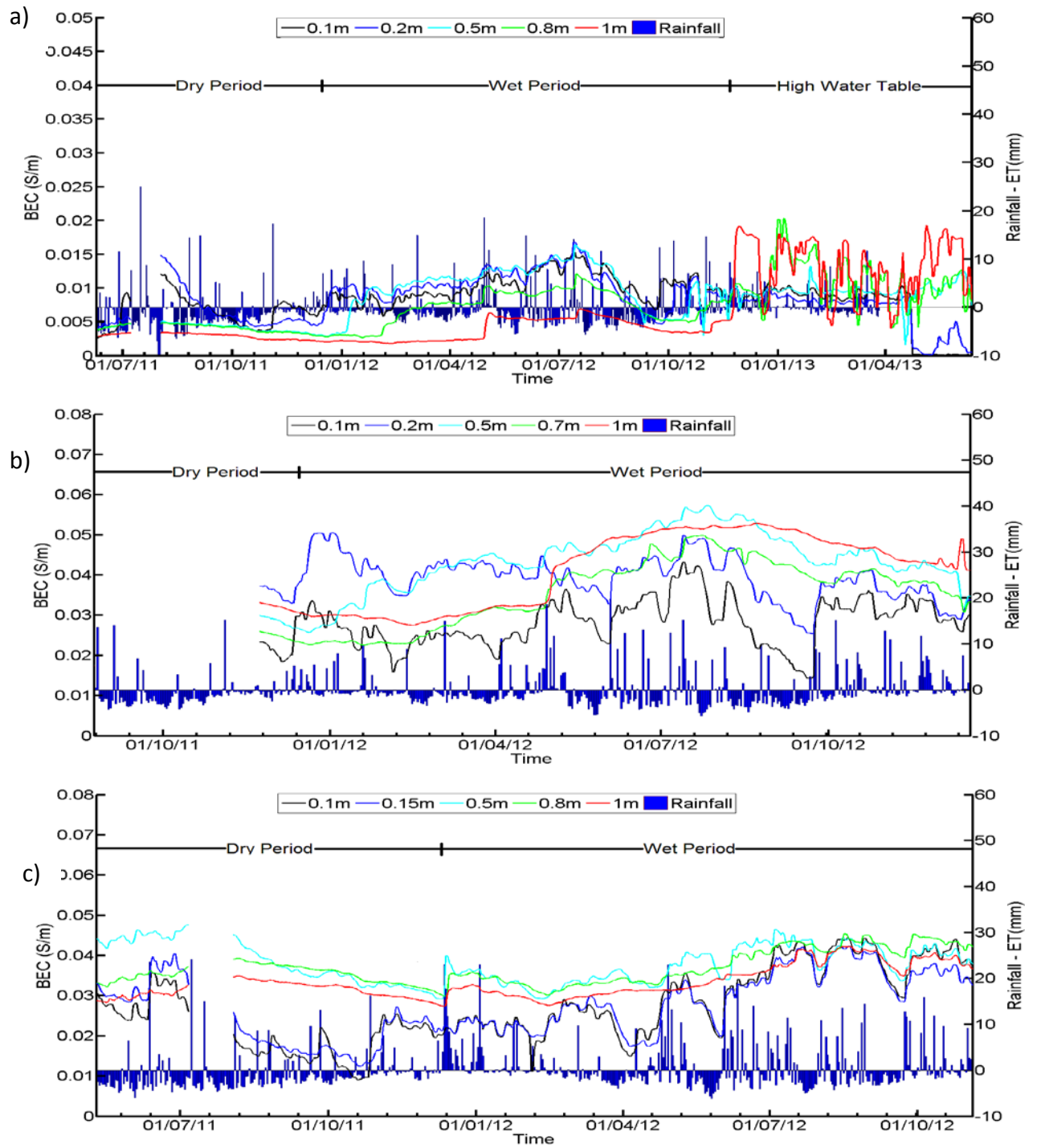

Figure 4: BEC and net rainfall over the study period at a range of depths for a) site A b) site B and c) site C

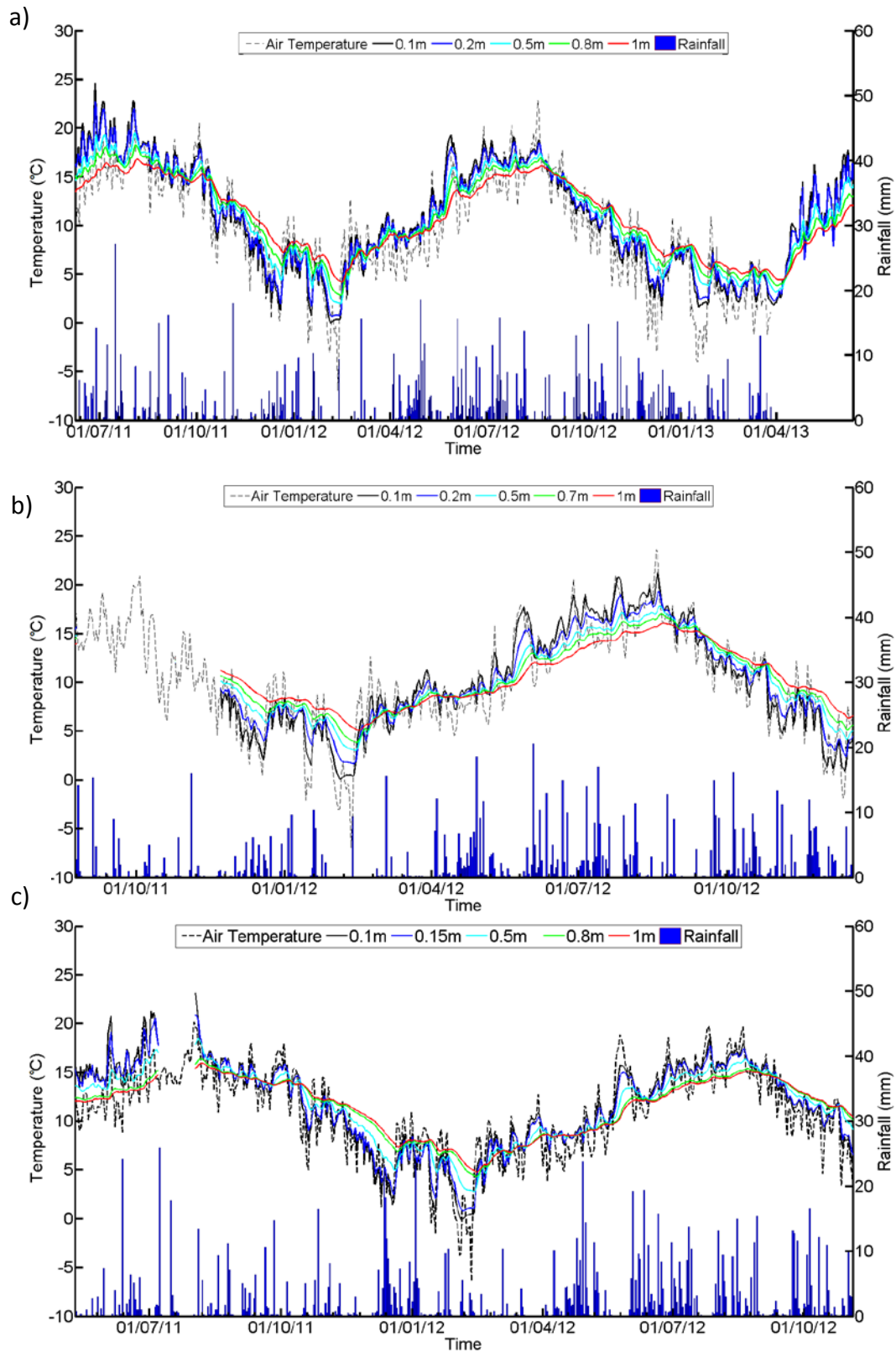

Figure 5: Daily averages of the air and soil temperature in °C over the study period at a range of depths for a) site A b) site B and c) site C

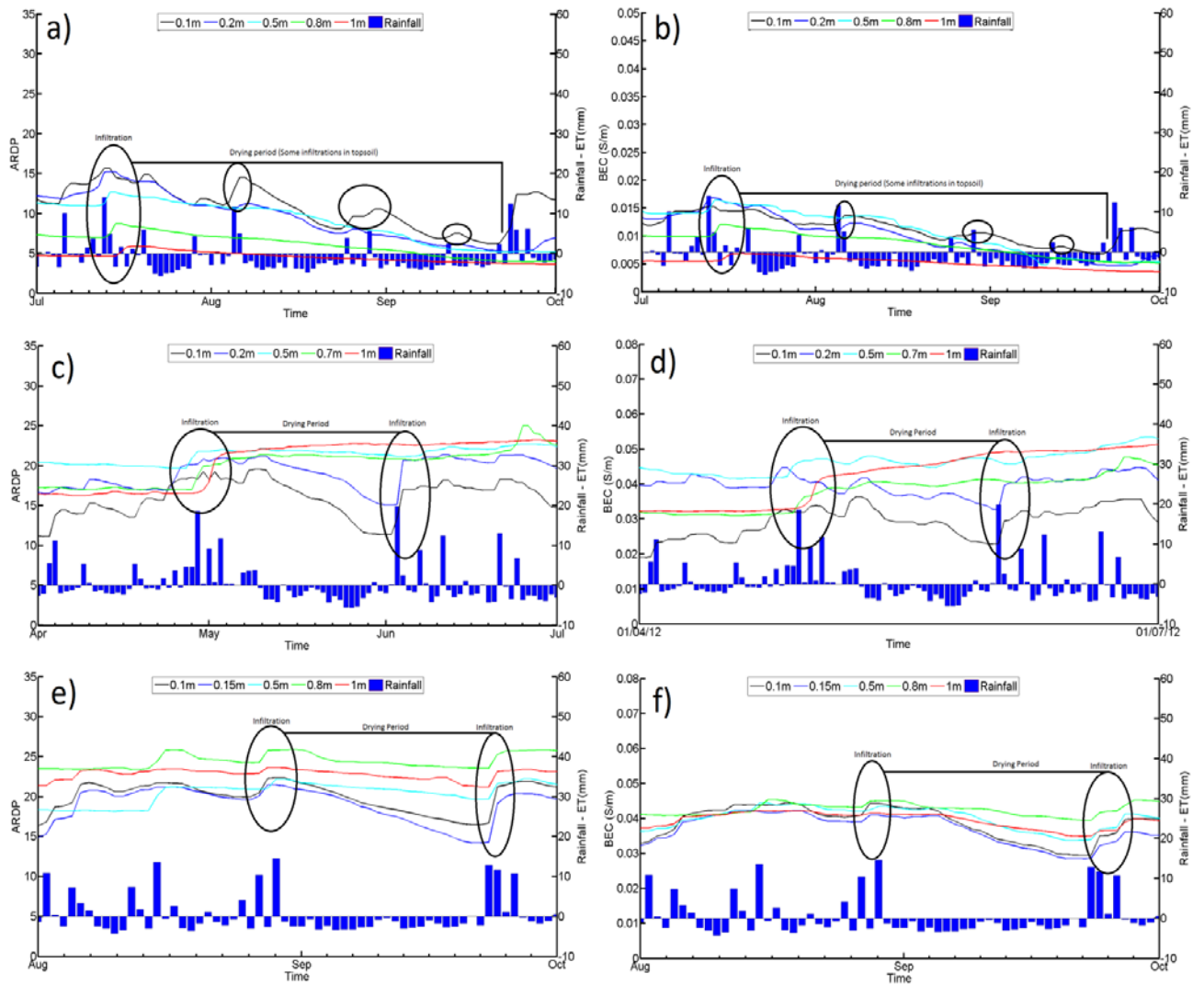
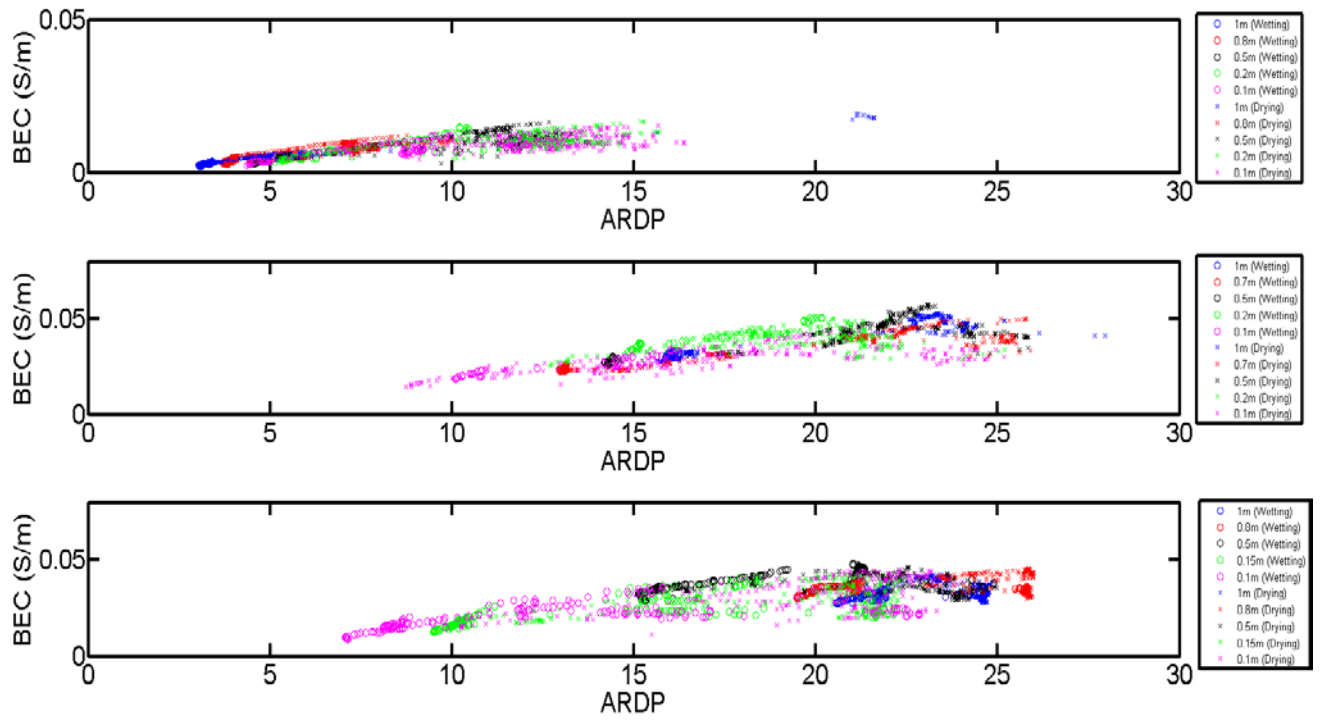

Figure 6: Hysteresis of geophysical properties on the studied sites due to the differences in infiltration and drying rates for Site A ARDP (a), Site A BEC (b), Site B ARDP (c), Site B BEC (d), Site C ARDP (e) and Site C BEC (f)



**Figure 7: Correlation between ARDP and BEC for both wetting and drying for the three sites**

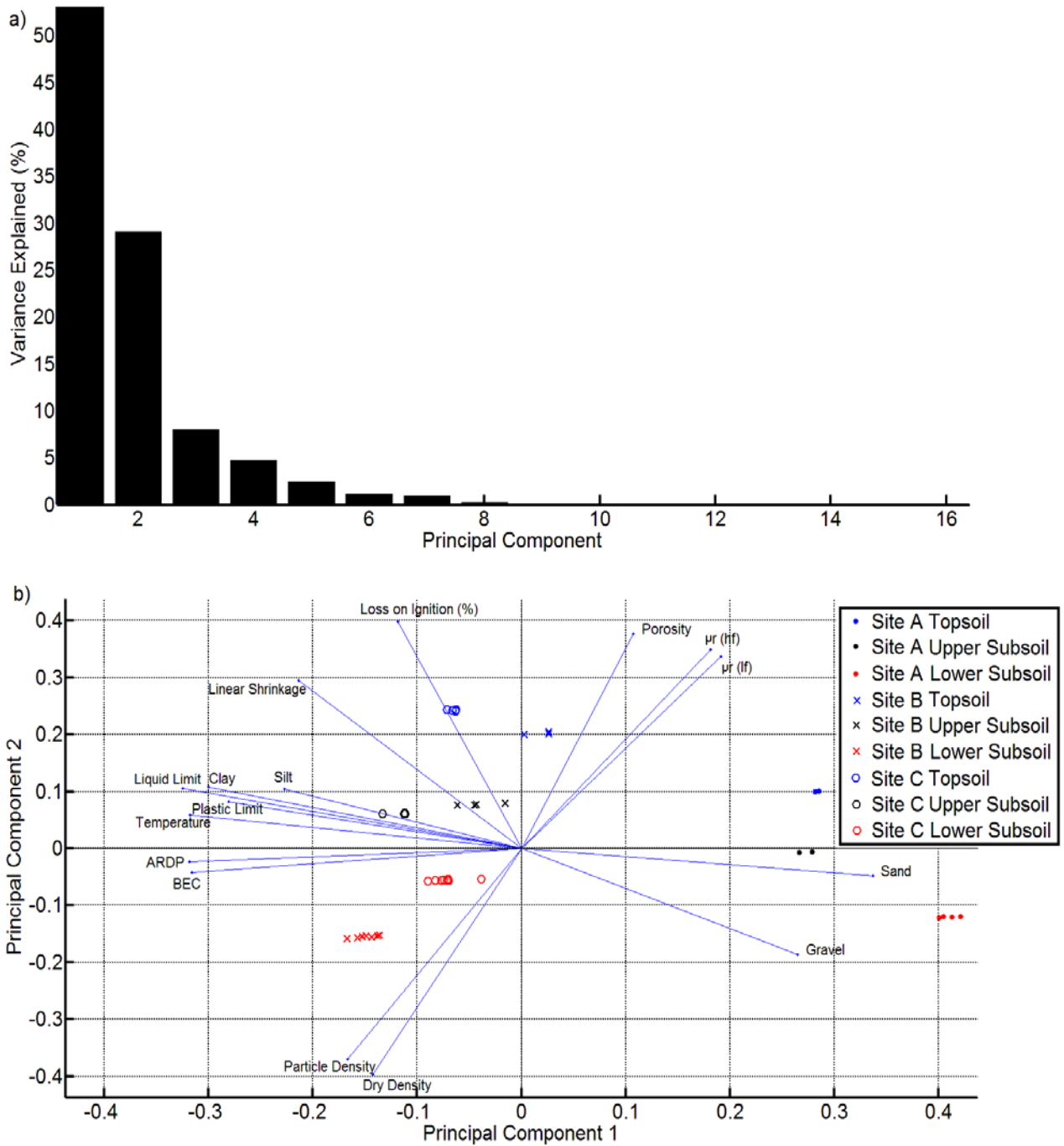

Figure 8: Principal component analysis (PCA) using the measured soil properties and average values for ARDP and BEC over the monitoring period featuring a) Scree plot b) Biplot output

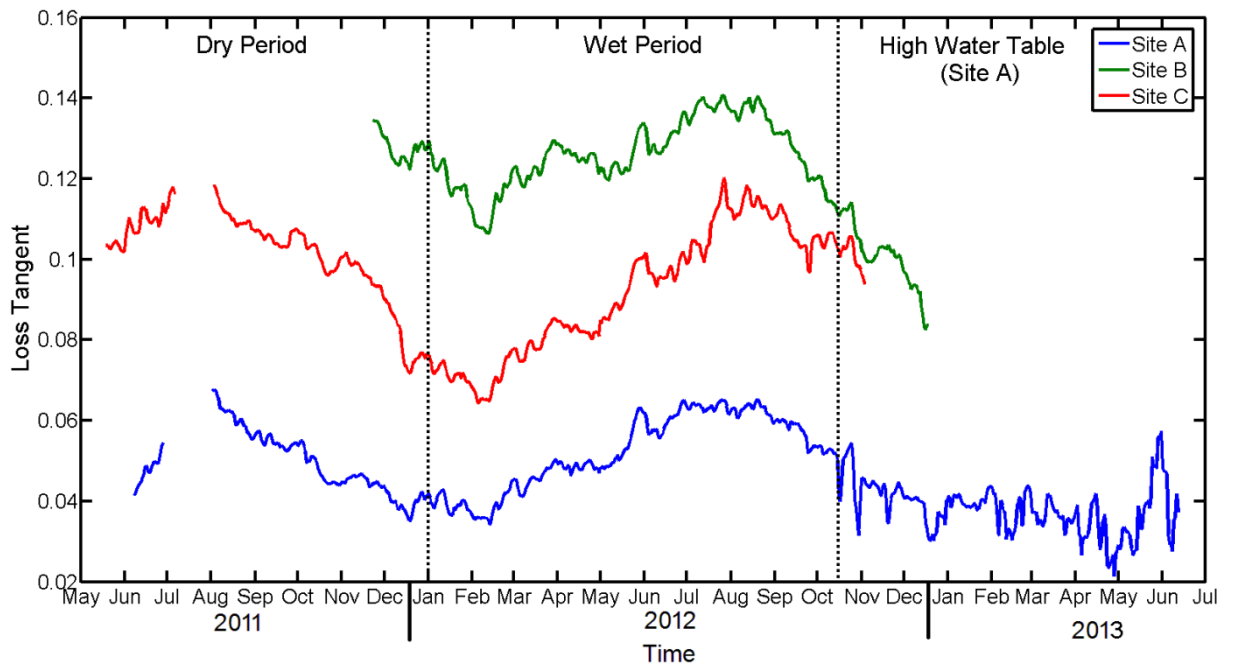

Figure 9: The calculated loss tangent for the three sites over the study period