

## From Industry 4.0 Digital Manufacturing to Industry 5.0 Digital Society

Ghobakhloo, Morteza ; Amoozad Mahdiraji, Hannan; Iranmanesh, Mohammad ; Jafari-Sadeghi, Vahid

DOI:

[10.1007/s10796-024-10476-z](https://doi.org/10.1007/s10796-024-10476-z)

License:

Creative Commons: Attribution (CC BY)

*Document Version*

Publisher's PDF, also known as Version of record

*Citation for published version (Harvard):*

Ghobakhloo, M, Amoozad Mahdiraji, H, Iranmanesh, M & Jafari-Sadeghi, V 2024, 'From Industry 4.0 Digital Manufacturing to Industry 5.0 Digital Society: a Roadmap Toward Human-Centric, Sustainable, and Resilient Production', *Information Systems Frontiers*. <https://doi.org/10.1007/s10796-024-10476-z>

[Link to publication on Research at Birmingham portal](#)

### General rights

Unless a licence is specified above, all rights (including copyright and moral rights) in this document are retained by the authors and/or the copyright holders. The express permission of the copyright holder must be obtained for any use of this material other than for purposes permitted by law.

- Users may freely distribute the URL that is used to identify this publication.
- Users may download and/or print one copy of the publication from the University of Birmingham research portal for the purpose of private study or non-commercial research.
- User may use extracts from the document in line with the concept of 'fair dealing' under the Copyright, Designs and Patents Act 1988 (?)
- Users may not further distribute the material nor use it for the purposes of commercial gain.

Where a licence is displayed above, please note the terms and conditions of the licence govern your use of this document.

When citing, please reference the published version.

### Take down policy

While the University of Birmingham exercises care and attention in making items available there are rare occasions when an item has been uploaded in error or has been deemed to be commercially or otherwise sensitive.

If you believe that this is the case for this document, please contact [UBIRA@lists.bham.ac.uk](mailto:UBIRA@lists.bham.ac.uk) providing details and we will remove access to the work immediately and investigate.



# From Industry 4.0 Digital Manufacturing to Industry 5.0 Digital Society: a Roadmap Toward Human-Centric, Sustainable, and Resilient Production

Morteza Ghobakhloo<sup>1,2</sup> · Hannan Amoozad Mahdiraji<sup>3</sup> · Mohammad Iranmanesh<sup>4</sup> · Vahid Jafari-Sadeghi<sup>5</sup>

Accepted: 7 February 2024  
© The Author(s) 2024

## Abstract

The present study addresses two critical controversies surrounding the emerging Industry 5.0 agenda. Firstly, it seeks to elucidate the driving forces behind the accelerated momentum of the Industry 5.0 agenda amidst the ongoing digital industrial transformation. Secondly, it explores how the agenda's sustainability values can be effectively realised. The study conducted a comprehensive content-centric literature synthesis and identified how Industry 4.0 shortcomings adversely impacted sustainability values. Furthermore, the study implements a novel approach that determines how and in what order the sustainability functions of Industry 4.0 should be leveraged to promote the sustainability objectives of Industry 5.0. Results reveal that Industry 4.0 has benefited economic and environmental sustainability values most at the organisational and supply chain levels. Nonetheless, most micro and meso-social sustainability values have been adversely impacted by Industry 4.0. Similarly, Industry 4.0 has been worryingly detrimental to macro sustainability values like social or economic growth equality. These contradictory implications of Industry 4.0 have pulled the Industry 5.0 agenda. However, the results identified nine sustainability functions of Industry 4.0 that, when leveraged appropriately and in the correct order, can offer important implications for realising the economic and socio-environmental goals of Industry 5.0. For example, under extreme unpredictability of business world uncertainties, the business should first leverage the automation and integration capabilities of Industry 4.0 to gain the necessary cost-saving, resource efficiency, risk management capability, and business antifragility that allow them to introduce sustainable innovation into their business model without jeopardising their survival. Various scenarios for empowering Industry 5.0 sustainability values identified in the present study offer important implications for knowledge and practice.

**Keywords** Industry 5.0 · Industry 4.0 · Sustainability · Digitalisation · Human-centricity · Resilience · Digital transformation

## 1 Introduction

Industry 5.0 has garnered significant attention and generated hype across industries, academia, and policy circles in recent years (Mukherjee et al., 2023). This emerging concept has sparked widespread interest and enthusiasm while also giving rise to debates and controversial opinions (Ivanov, 2023). After several development iterations, a prevailing consensus has emerged that Industry 5.0 does not constitute an independent industrial revolution; instead, it is a policy framework that builds upon the advancements achieved in Industry 4.0 (Ghobakhloo et al., 2023a). Its primary

objective is to govern and regulate the trajectory of Industry 4.0 progression (Breque et al., 2021). Therefore, it is evident that Industry 5.0 should be understood within the context of over a decade of advancements and progress in Industry 4.0 (Huang et al., 2022). It emerges as a phenomenon that builds upon the foundation laid by its predecessor, leveraging the cumulative knowledge, technological innovations, and transformative potential of Industry 4.0 (Müller, 2020; Renda et al., 2022).

The ongoing discourse on Industry 5.0 has sparked attention and controversies, especially for companies shaping their future digitalization strategies (Hein-Pensel et al., 2023). As Industry 5.0 gains momentum alongside the persistent influence of Industry 4.0, businesses face the challenge of determining whether Industry 4.0 remains a viable

---

Extended author information available on the last page of the article

framework or if a shift to Industry 5.0 is already necessary (Huang et al., 2022). A key debate centres on the technological aspects of Industry 5.0. While some view it primarily as a governance framework, others argue for its close association with technological advancements, particularly the commercialization of generative artificial intelligence (Maddikunta et al., 2022). This dual perspective complicates strategic decisions for companies aiming to balance productivity and societal values. Navigating this landscape requires a nuanced understanding of the interplay between governance and technology, which has been significantly lacking within the literature.

Therefore, and within the realm of Industry 5.0, two significant knowledge gaps require further exploration and understanding. Firstly, there is a need to uncover the reasons behind the swift and unprecedented rush towards Industry 5.0. Despite Industry 4.0 still being in the process of maturation and widespread implementation (Cañas et al., 2021), the emergence of Industry 5.0 has sparked intense debates and propelled its adoption (Müller, 2020). To address this knowledge gap, it is crucial to delve into the factors driving this rapid shift, including the influence of technological advancements, socio-economic factors, policy initiatives, and market forces. Understanding the motivations and drivers behind the accelerated push towards Industry 5.0 will shed light on the underlying forces shaping this phenomenon. Understanding the drivers behind the swift adoption of Industry 5.0 is not just insightful but a critical necessity for companies aiming to stay competitive and strategically positioned. Unfortunately, this crucial knowledge is deeply underdeveloped, resulting in missed opportunities for informed investment, strategic innovation, and proactive risk mitigation during digital industrial transformation. Without a clear comprehension of the driving forces, companies may struggle to optimize operational efficiency, integrate sustainable practices, and attract and retain top talent in an industry undergoing rapid transformation. In essence, the absence of this essential knowledge poses a significant challenge for companies seeking sustained success in a dynamic and evolving business landscape.

Secondly, it is imperative to explore how the ongoing digital industrial transformation can be effectively managed to achieve the overarching objectives that Industry 5.0 prioritises. Industry 5.0 aims to create a sustainable, human-centric, and resilient future industry (Ghobakhloo et al., 2022; Karmaker et al., 2023). However, realising these objectives requires a comprehensive understanding of the mechanisms, strategies, and frameworks needed to facilitate the successful integration and governance of digital technologies within the industrial ecosystem. Addressing this knowledge gap involves examining the best practices, policies, and approaches that can maximise the positive impacts of digitalisation while minimising

potential negative consequences. It entails exploring the role of various stakeholders, including businesses, governments, labour unions, and society at large, in ensuring that the ongoing digital industrial transformation aligns with the core objectives of Industry 5.0. For companies developing their future digitalization strategy, the lack of a comprehensive understanding regarding the management of the ongoing digital industrial transformation poses a significant challenge. Industry 5.0 envisions a future industry characterized by sustainability, human-centricity, and resilience. However, navigating the complexities of the digital industrial landscape becomes challenging without a thorough grasp of essential mechanisms, strategies, and frameworks for integrating and governing the digital technologies of Industry 4.0. This knowledge gap impedes the development of informed solutions aligned with Industry 5.0's goals, hindering the optimization of positive impacts while mitigating potential negative consequences among organizations. Consequently, this challenge jeopardizes companies' ability to shape their digitalization strategies in alignment with Industry 5.0's envisioned future industry, hindering progress toward a transformative and harmonized industrial landscape.

Accordingly, the study pursues two primary objectives to bridge the identified knowledge gap. The first objective is to comprehensively grasp the unprecedented emergence of Industry 5.0, probing into potential connections with the corporate and societal impacts of Industry 4.0. The second objective is to pinpoint the sustainability mechanisms within Industry 4.0 that have demonstrated real-world viability, subsequently exploring the feasibility of leveraging these mechanisms to align corporate digital transformation with the socio-environmental values inherent in Industry 5.0.

In addressing the first objective, the present study draws on the sustainability perspective and systematically reviews the positive and negative contributions of Industry 4.0 to the economy, environment, and society. The literature proposes that Industry 4.0 represents a techno-economic phenomenon involving the digital transformation of value networks across various industries (Shayganmehr et al., 2021). Although Industry 4.0 mainly centres around the digitalisation of industrial entities, its ripple effects reach far beyond the business floor. The industrial transformation under Industry 4.0 and, in many cases, the disruptive technological innovations pushing such transformation also impact the environment and society (Kovacs, 2018). Literature provides controversial perspectives on the contribution of Industry 4.0 to sustainability, depending on the scope and level of analysis. For example, as the core objectives of Industry 4.0, productivity and efficiency reduce resource consumption and waste across

industrial operations (Enyoghasi & Badurdeen, 2021). Therefore, Industry 4.0 and the underlying digitalisation may contribute to cleaner production operations at the micro-industrial<sup>1</sup> analysis level (Mubarik et al., 2021). Besides, the information processing and interconnectedness capabilities of Industry 4.0 may offer unique opportunities for environmental and social sustainability (Stock et al., 2018).

Conversely, the literature acknowledges that Industry 4.0 is a technology-driven phenomenon that systematically disregards many aspects of socio-environmental sustainability, especially at the meso (e.g., supply chain) and macro-regional analysis levels (Kovacs, 2018; Soh & Connolly, 2020, 2021). For example, experts are deeply concerned about the negative social-environmental impacts of Industry 4.0, such as job exclusivity, income polarisation, digital divide, business fragility, and rebound effect (Grybauskas et al., 2022). Since the literature tends to provide a vague understanding of Industry 4.0 adverse effects on sustainability, the present study conducts a content-centric review of Industry 4.0-sustainability associations to explain better what functional and technological design flaws of Industry 4.0 have led to the prevalence of Industry 5.0 agenda.

To address the second objective, the study draws on the literature and experts' opinions to answer the second research question of how ongoing digital industrial transformation could address Industry 5.0 key goals. We acknowledge that while preceding industrial revolutions took decades to unfold, Industry 5.0 seems to coexist with Industry 4.0 as a parallel phenomenon. As a sociotechnical phenomenon, Industry 5.0 directly addresses significant shortcomings of Industry 4.0: being a purely technology-centred and profit-driven phenomenon. From this perspective, Industry 5.0 entails regulating and managing the digitalisation pushed by Industry 4.0, leading to an eco-friendlier, human-centric, and resilient future industry (Huang et al., 2022). Consistently, the present study aims to identify the functions through which the ongoing digital industrial transformation can contribute to developing the core objectives of Industry 5.0. The study aims to identify the interrelationships among these functions and map them into an interpretive roadmap of a human-centric, sustainable, and resilient industry that facilitates the Industry 5.0 agenda.

We employ a comprehensive and novel exploratory research method to achieve the research objectives. The decision to adopt an exploratory research design stems from the limited maturity and emerging nature of the Industry

5.0 literature. Both Industry 4.0 and Industry 5.0 represent expansive and dynamic domains that are constantly evolving. Furthermore, there is a notable dearth of sufficient theoretical development explaining how the sustainability mechanisms of Industry 4.0 interact to drive the objectives of Industry 5.0. Therefore, we drew on the exploratory research design to explore these complex and underdeveloped facets.

To achieve the research objectives, our methodology starts by conducting a content-centric evidence synthesis of Industry 4.0 literature to perform evidence mapping of Industry 4.0 sustainability performance. By doing so, the study identifies the positive and negative contributions of Industry 4.0 to various aspects of sustainability, allowing us to identify techno-functional weaknesses of this phenomenon that lead to the unforeseen emergence of the Industry 5.0 agenda. The study further builds on the evidence synthesis of Industry 4.0 literature to identify sustainability functions essential to developing Industry 5.0 objectives. The study captures experts' opinions on the sustainability functions identified and applies a novel Hesitant-Fuzzy set (HFs) Interpretive Structural Modelling (ISM) approach to identify and model the interdependencies among the functions. The resulting *scenarios* explain how the sustainability functions of Industry 4.0 should be leveraged to promote three central sustainability objectives of Industry 5.0 under various unpredictability levels of business uncertainties.

The study is believed to offer important theoretical implications. The content-centric literature review reveals that Industry 4.0 has controversial implications for sustainability. While it has positively impacted economic and environmental sustainability at micro and meso levels, its effects on social and macro sustainability are inconclusive. These findings help explain the acceleration towards Industry 5.0, which aims to govern and regulate Industry 4.0's digital transformation to prioritise socio-environmental goals alongside productivity. The study also identifies the potential of Industry 4.0 functions to promote sustainability values and proposes a novel approach, HF-ISM, to understand how these functions should interact to fulfil Industry 5.0's sustainability objectives.

The study's HF-ISM approach offers notable practical implications, boosting understanding of the sequential interaction of sustainability functions within Industry 4.0. Three scenarios were identified based on different levels of business uncertainties. In Scenario 1, mature and stable corporations can capitalise on the innovation opportunities of Industry 4.0, enabling other sustainability functions simultaneously. Scenario 2 emphasises leveraging functions like business risk management, smart product integration, and supply chain performance to promote sustainability strategies and resource efficiency. Scenario 3, applicable to highly turbulent environments, prioritises automation, circularity, and real-time communication capabilities to adapt to

<sup>1</sup> The microscopic level refers to the organisational analysis level, whereas the mesoscopic level mainly concerns outcomes at the supply chain or intraregional business sector level. The macroscopic level relates to large-scale outcomes at the societal or global scale.

unpredictable changes. These scenarios highlight the importance of synergy and sequence in leveraging Industry 4.0 functions to align with the sustainability values of Industry 5.0. Businesses should consider their internal and external environments to determine the most suitable scenario. Regardless of the scenario, each function uniquely promotes Industry 5.0 sustainability values, emphasising the need to consider all sustainability functions in governance strategies.

## 2 Background

In this section, we provided a synoptic overview of the evolution of the Industry 5.0 agenda, discussing its core objectives. We further conducted the evidence synthesis of Industry 4.0-sustainability literature to identify to what extent the ripple effects of Industry 4.0 have been aligned with sustainability values.

### 2.1 Synoptic Overview of Industry 5.0

Even though the Industry 5.0 concept is nascent, it has constantly evolved over the past few years. Industry 5.0 was first introduced in the literature around 2016, with Sachsenmeier (2016) suggesting that it signifies a significant geostrategic transformation driven by the progress in synthetic biology technologies. Özdemir and Hekim (2018) criticised the systematic vulnerability of the Industry 4.0 ecosystem and proposed that Industry 5.0 capitalises on symmetrical innovation to democratise knowledge via orchestrated utilisation of disruptive technologies like AI, big data, and IoT. These early speculations were contradicted by an emerging school of thought arguing that Industry 4.0 inadvertently disregards humans within the industrial context (Longo et al., 2020). Therefore, scholars such as Doyle Kent and Kopacek (2021) and Nahavandi (2019) proposed that Industry 5.0 would represent a technological revolution that empowers man-machine symbiosis and assists human operators, particularly in manufacturing.

European Commission cautiously approached this concept in 2020 and acknowledged a few controversies that might be associated with the term ‘Industry 5.0’ (Müller, 2020). For example, Industry 4.0 is still evolving, and many businesses, particularly smaller ones, are far behind industry leaders in implementing the technological constituents of Industry 4.0. Second, Industry 4.0 and Industry 5.0 are similar on various fronts, especially concerning the fundamental technologies, design principles, and productivity objectives. Third, prior industrial revolutions, including Industry 4.0, have all been pushed by technological innovation, whereas Industry 5.0 appears to be pulled by socio-environmental values (Müller, 2020). In the 2021 policy brief, the European Commission held a firmer position toward this emerging

concept and explained that Industry 5.0 complements Industry 4.0 in recognising the value of digital industrial transformation for preserving the environment and society (Breque et al., 2021). From this perspective, Industry 5.0 cannot be regarded as the chronological substituent of Industry 4.0. As a forward-looking agenda, it instead builds on the hallmark technologies, principles, and components of Industry 4.0 to promote sustainability, mainly manifested in environmentalism, human-centricity, and economic resilience. European Commission offered a more resolute opinion regarding Industry 5.0 in their 2022 policy brief and explicitly declared that Industry 4.0 can no longer serve as an appropriate agenda for Europe’s future goals (Renda et al., 2022). This policy brief argued that while both concepts share certain technological and techno-functional similarities, Industry 5.0 supersedes its predecessor in providing the directionality needed for a competitive and sustainable future industry. Viewed from this perspective, the intended values of Industry 5.0 expand beyond productivity-driven economic growth, involving economic circularity, environmental sustainability, human-centricity, social values, and long-run resilience (Renda et al., 2022). This perspective proposes that Industry 5.0 can manifest in the stakeholder-driven governance of ongoing digital industrial transformation.

Recent studies have widely accepted the European Commission’s perspective on the scope and objectives of Industry 5.0 (Huang et al., 2022; Maddikunta et al., 2022). Indeed, the most recent contributions to the scholarly literature widely acknowledge that Industry 5.0 goes beyond the value-centricity of Industry 4.0 by pursuing sustainability values (Ivanov, 2022). In particular, the Industry 5.0 reference model by Ghobakhloo et al. (2022, p. 719) explains that this phenomenon should not be merely regarded as “economic-productivity driven as it systematically pursues balancing economic and socio-environmental sustainability.” They further highlight that under the Industry 5.0 agenda, economic and socio-environmental aspects of sustainability are interlinked, and synergetic complementarity among various sustainability goals of Industry 5.0 can offer valuable implications for sustainable development.

Following the European Commission’s perspective on the sustainability goals of Industry 5.0 and studies that endorse such a standpoint (e.g., Ghobakhloo et al., 2022; Ivanov, 2022), the present study postulates that the core objective of Industry 5.0 involves promoting the economic, environmental, and social aspects of sustainability at the microscopic, mesoscopic, and macroscopic scales. Nevertheless, our study takes a forward-looking approach to operationalizing the Industry 5.0 concept.

The present study aligns with the prevailing perspective that Industry 5.0 serves as a socially driven governance agenda, redirecting the ongoing digital industrial transformation (referred to as Industry 4.0) toward inclusive

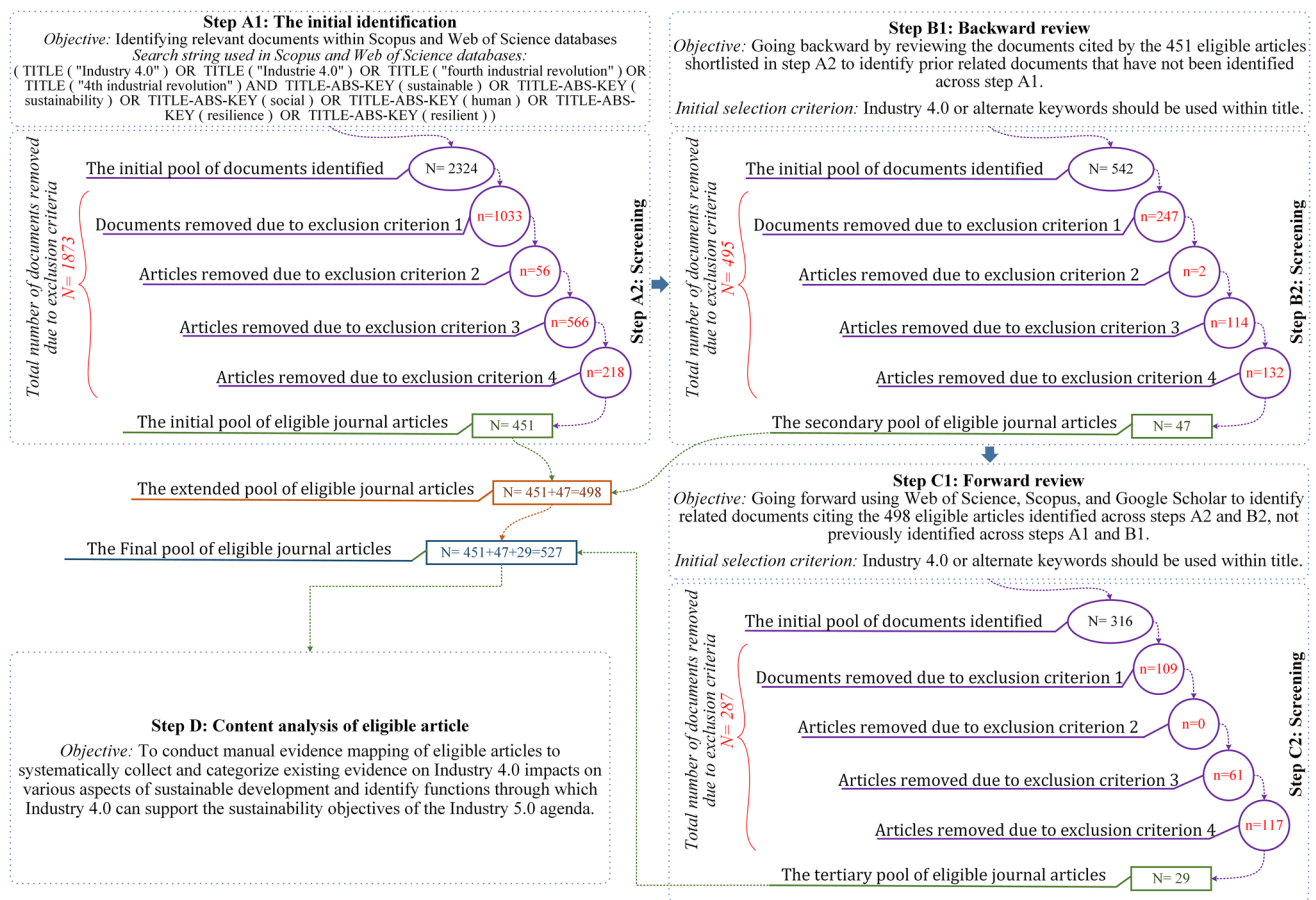

Fig. 1 Steps for conducting the content-centric synthesis of Industry 4.0-sustainability literature

sustainability (Sindhvani et al., 2022). By introducing technology and business governance policies, Industry 5.0 regulates the pace of Industry 4.0 transformation, guiding the digital business landscape toward societal values. Achieving the ambitious societal goals associated with Industry 5.0 demands purposeful management and leveraging of Industry 4.0 technologies and design principles (Huang et al., 2022). However, it is crucial to recognize the emergence of generative artificial intelligence, exemplified by tools like ChatGPT, as a significant technological milestone with the potential to shape a new industrial era (Ooi et al., 2023). Recent studies acknowledge generative artificial intelligence as a critical technological component of Industry 5.0 (e.g., Ghobakhloo et al., 2023b), suggesting transformative power that could position Industry 5.0 as the next phase of industrial transformation. These unprecedented technologies are reshaping business dynamics and may extend beyond the trajectory of Industry 4.0.

In light of these emerging technologies, Industry 5.0 can be understood in two ways. First, it can be regarded as a policy agenda driven by social factors and propelled by technological advancements, aiming to capitalize on the potentials

offered by Industry 4.0 technologies while maintaining a balance between economic growth and socio-environmental development (Huang et al., 2022). Second, Industry 5.0 may have the potential to be considered the next industrial revolution, especially with emerging technologies like general artificial intelligence appearing to cause a significant shift in the industrial development landscape (Ghobakhloo et al., 2023b). While our present study aligns more with the first perspective, we also acknowledge the importance of recognizing the second perspective.

## 2.2 Evidence Synthesis of Industry 4.0-Sustainability Literature

The study conducted a content-centric evidence synthesis of the literature to identify (1) positive or negative contributions of Industry 4.0 to various sustainability aspects and (2) functions based on which Industry 4.0 may contribute to sustainability. Following the existing guidelines (e.g., Webster & Watson, 2002; Watson & Webster, 2020), evidence synthesis of the literature in this study involves multiple steps explained in Fig. 1. Step A1 of the evidence

**Table 1** Exclusion criteria applied for resource identification

Exclusion criterion	Description
1	The document is not categorised as a peer-reviewed academic journal article (e.g., conference papers or proceedings).
2	The article is not written in English.
3	The article uses the search keywords merely in the title/abstract/keywords and provides no insight into the Industry 4.0 phenomenon.
4	The article does not discuss the implications of Industry 4.0 for sustainability whatsoever.

synthesis involved using the search string presented in Fig. 1 to search Scopus and Web of Science databases to identify relevant documents. Keywords such as human or resilience were included in the search string because the Industry 5.0 concept prioritises human centricity, resilience, and sustainability (Ivanov, 2022; Renda et al., 2022). The search in step A1 was conducted in mid-2022, in which no specific limitations such as date range were applied. As explained in Fig. 1, executing step A1 identified 2324 potentially related documents. Step A2 entailed subjecting the document identified across step A1 to the exclusion criteria in Table 1. To ensure the reliability and dependability of findings, exclusion criterion 1 limited the eligibility documents to peer-reviewed academic journal articles. Exclusion criteria 3 and 4 ensured that the eligible articles shortlisted would provide meaningful insights into Industry 4.0-sustainability interactions. Overall, the decision to use exclusion criteria in Table 1 is widely supported by comparable review studies within the Industry 4.0 literature (e.g., Ching et al., 2022; Ghobakhloo et al., 2021a). Subjecting the 2324 identified documents to the exclusion criteria resulted in excluding 1873 documents. As a result, 451 articles were shortlisted under the initial pool of eligible journal articles.

Step B1 concerned the backward review of the eligible articles shortlisted in step A2. This step involved screening the reference section of the 451 eligible articles and identifying documents that mention Industry 4.0 or any related keywords within their title. Step B1 identified 542 unique documents not previously identified across step A1. In step B2, these documents were subjected to the exclusion criteria, which resulted in the exclusion of 495 documents. Step B2 led to the secondary pool of 47 eligible journal articles. Next, the forward review of eligible articles was conducted in step C1. In this step, the research team used Google Scholar, Web of Science, and Scopus platforms to identify related documents that cited any of the 498 (451 + 47) eligible articles identified across steps A2 and B2. Step C1 identified 316 unrecognised documents across steps A1 and B1. Step C2 involved applying the exclusion criteria to these newly identified documents, removing 287 ineligible documents. As a result, the tertiary pool of 29 eligible articles was established in step C2. Steps A2, B2, and C2

collectively led to the final pool of 527 articles eligible for content analysis.

In Step D of the evidence synthesis, which entailed the manual content analysis and evidence mapping of eligible articles, a meticulous and rigorous approach was followed to ensure the credibility and robustness of the findings.

A data-driven methodology was employed for theme generation, where themes emerged organically from the content analysis process. The coding phase involved a meticulous line-by-line examination of the eligible articles, facilitating the identification of meaningful information units. This detailed approach ensured a thorough exploration of the text, preserving a granular level of analysis. From the coded data, descriptive themes were developed, encapsulating the principal areas of focus and content about the sustainability outcomes of Industry 4.0 across three levels of analysis and three sustainability pillars. These descriptive themes provided a comprehensive and systematic overview of the information.

Furthermore, the analysis proceeded beyond the descriptive themes, further exploring the data to generate analytical themes. This involved a comprehensive exploration of the relationships, connections, and implications within the data, enabling the identification of key concepts and perspectives that contributed to a more nuanced understanding of the topic. The analytical themes represented a higher level of abstraction, shedding light on the interconnections, contradictions, and emerging trends in the literature. Through this rigorous process, a comprehensive and nuanced analysis of the collected data was achieved, facilitating the identification of the sustainability functions of Industry 4.0.

To establish the reliability and validity of the findings, the research team adhered to established guidelines and best practices in qualitative research (e.g., Thomas & Harden, 2008; White & Marsh, 2006). Independent content assessors conducted the content analysis, ensuring an objective data evaluation. Any disagreements or discrepancies in findings were meticulously tracked and addressed at the individual article level. Extensive discussions and comparisons were undertaken among the research team members to reach a shared consensus on the content analysis findings. This iterative process enhanced the reliability and validity of the analysis by minimising subjectivity and ensuring the robustness

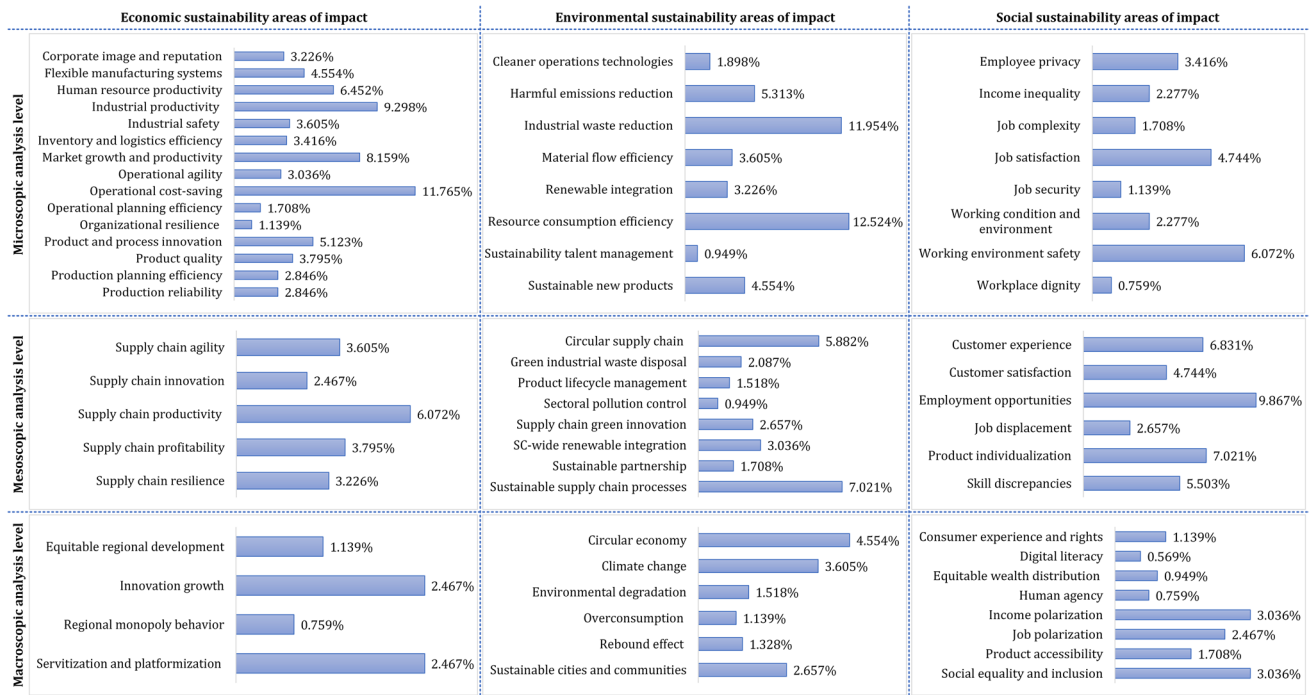

Fig. 2 Sustainability impacts of Industry 4.0 and their acknowledgement rate within the literature

of the interpretations. The research team further applied evidence mapping to visually classify and compare the Industry 4.0 areas of impact in sustainability. Evidence mapping is a user-friendly modern methodology commonly used to provide a high-level visual overview of the state of evidence over a specific phenomenon and its impacts (Kondo et al., 2019). The content analysis results are discussed in the following sections.

### 2.2.1 The Sustainability Impacts of Industry 4.0

Content analysis results revealed that scholars had studied the sustainability implications of Industry 4.0 across various analysis levels and impact areas. Eligible articles frequently drew on the triple bottom line framework to separately report the economic, environmental, and social sustainability implications of Industry 4.0 (Nara et al., 2021). Alternatively, the literature commonly distinguishes the micro-sustainability impacts of Industry 4.0 from macroscale impacts (Adamik & Sikora-Fernandez, 2021). The present study adapts to these classifications and presents the sustainability implications of Industry 4.0, as shown in Fig. 2. This figure structures the Industry 4.0 sustainability implications in the form of a three-by-three matrix based on analysis levels and impact areas. Under the analysis levels, the microscopic level refers to the organisational analysis level, where Industry 4.0 outcomes are assessed in the individual or firm context. The mesoscopic level mainly concerns evaluating Industry 4.0

outcomes at the supply chain (or specific regional business sector) level, whereas the macroscopic level relates to large-scale Industry 4.0 outcomes at the societal or global scale. The impact area in Fig. 2 consists of the economic, environmental, and social pillars of sustainability, which are thoroughly discussed and elaborated on within the literature (Toktaş-Palut, 2022). This classification in Fig. 2 leads to 9 blocks and sustainability impact, from the micro-economic block to the macro-social block. Each block lists the underlying sustainability indices among the eligible articles along with their respective acknowledgement rate. For example, under the micro-environmental block, 12.524% of eligible articles acknowledged that Industry 4.0 significantly impacts the resource consumption efficiency of individual firms.

The study draws on the results of evidence synthesis and develops the evidence map of Industry 4.0's sustainability implications, as shown in Fig. 3. This figure is compatible with Fig. 2 in the sense that it offers similar categorisation of Industry 4.0 sustainability implications under similar blocks. However, this map explicitly describes the extent to which Industry 4.0 positively or negatively impacts each sustainability index, as perceived by the scholarly literature. As seen in the legend part of Fig. 3, rectangles of four different sizes have been used to depict the acknowledgement level (rate) of each sustainability index. For example, the smallest rectangle represents sustainability indices with an acknowledgement rate of less than 3% (among the 527 eligible articles), while the largest rectangle represents sustainability indices



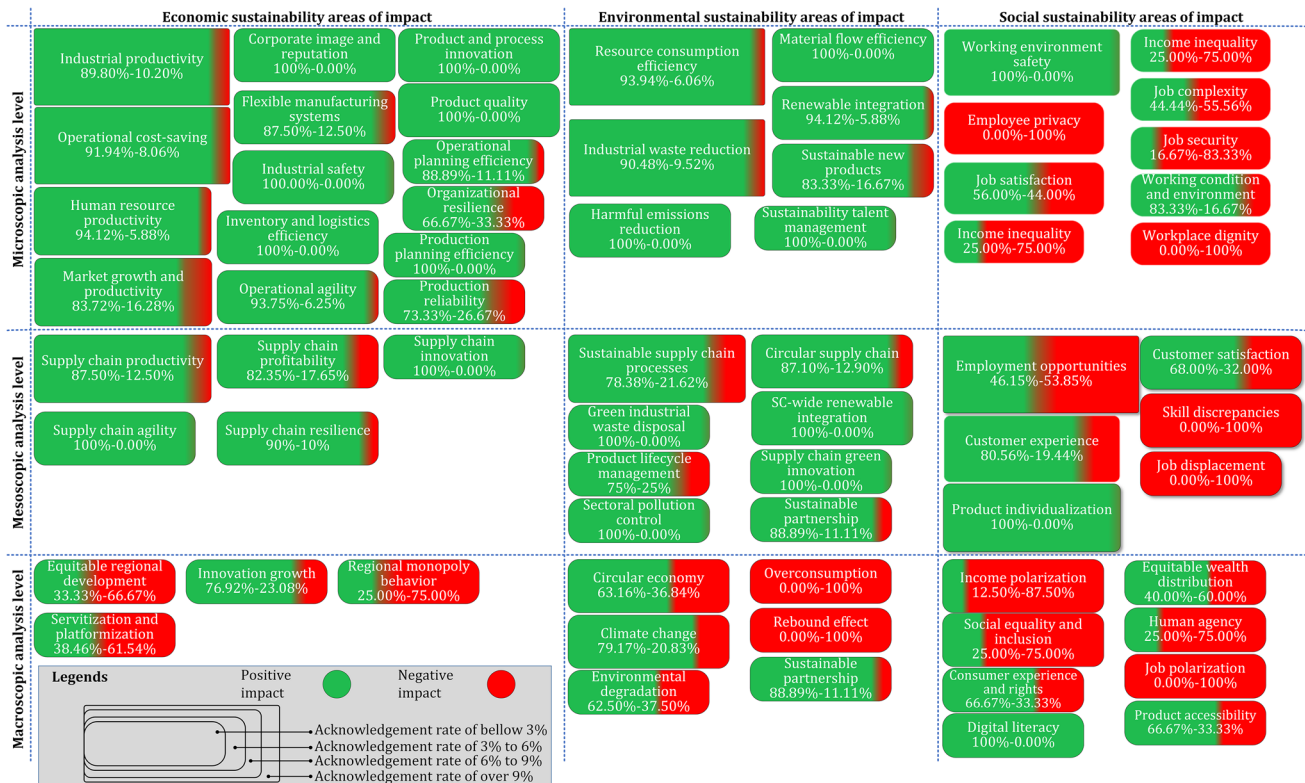

**Fig. 3** The evidence map of the positive and negative impacts of Industry 4.0 on various aspects of sustainability

with an acknowledgement rate of more than 9%. The green colour in Fig. 3 should be inferred as the positive impact of Industry 4.0 on a specific sustainability index, whereas the red colour should be interpreted as a negative impact. The proportionality of green colour to red colour in a given rectangle corresponds to the extent to which Industry 4.0 has been reported to positively or negatively impact a given sustainability index. Figures 2 and 3 collectively describe how the literature has observed Industry 4.0 to positively or negatively impact various aspects (indices) of sustainability.

Figures 2 and 3 show that the micro-economic sustainability implications of Industry 4.0 have received the most attention within the literature. Eligible articles have identified 15 sustainability indices under this block. Results reveal that Industry 4.0 contribution to micro-economic sustainability has been dominantly positive. The most acknowledged contribution of Industry 4.0 to this area involves enhancing the industrial productivity and operational cost-saving of individual firms (Kiel et al., 2017; Strandhagen et al., 2020). Indeed, the literature offers detailed insights into how Industry 4.0 may promote sustainability indices under this block. For example, scholars such as Chen et al. (2021) and Dev et al. (2020) explained how industrial units could draw on disruptive technological constituents of Industry 4.0, including additive manufacturing, industrial robotics, and digital twin, to promote product and process innovation. Not all

scholars believe that Industry 4.0 contributions to micro-economic sustainability are unconditionally positive, particularly concerning productivity, organisational resilience, and production reliability (e.g., Chiarini et al., 2020; Chiarini, 2021; Dalenogare et al., 2018). While acknowledging these negative impacts, scholars such as Ghobakhloo and Fathi (2020) and Song et al. (2022) argue that Industry 4.0 technologies inherently favour productivity and performance improvement. However, they can cause temporary operational disruption and productivity loss during the initial implementation stages. Alternatively, the cybersecurity immaturity of implementing firms may allow malicious actors to target Industry 4.0 technologies and hamper the resilience or reliability of business operations (Bécue et al., 2021).

Content analysis results also identified seven micro-environmental sustainability indices, which, in most cases, have been positively affected by Industry 4.0. In particular, the literature widely acknowledges that Industry 4.0 enables individual firms to improve resource consumption efficiency (Dixit et al., 2022; Margherita & Braccini, 2020), reduce waste (Psarommatis et al., 2021), and increase material flow efficiency (Sun et al., 2022; Vlachos et al., 2021). These positive micro-sustainability contributions generally root in Industry 4.0 unique features, such as continuous real-time process monitoring (Mishra et al., 2018) or AI-driven

resource management and prioritisation optimisation (Amjad et al., 2021; Fathi & Ghobakhloo, 2020). Industry 4.0 also allows businesses to use AI, big data analytics, and predictive models to develop smart-hiring platforms that identify suitable talents with the needed sustainability competencies (Ghobakhloo et al., 2021a). Scholars also report that smart human resource platforms under Industry 4.0, also known as HRM4.0, can offer analytical insights into employees' sustainability productivity (Rana & Sharma, 2019) and help the management team to develop better sustainability training and development programs for employees (Al Amiri & Shawali, 2021; Vereycken et al., 2021). Nonetheless, the literature highlights a few cases where Industry 4.0 negatively impacts some micro-environmental sustainability indices (Oláh et al., 2020). For example, smart manufacturing facilities have much higher energy consumption due to the intensive energy needs of industrial robots, automated guided vehicles, or sensor-equipped and connected machinery (Chiarini, 2021). In addition, the dimensionality and complexity of intelligent production systems and smart products under Industry 4.0 challenge the implementation of circularity and sustainable operations (Abdul-Hamid et al., 2020; Hennemann Hilario et al., 2022).

Contrary to the micro-economic and environmental blocks, the literature reports Industry 4.0 implications as mostly negative for micro-social sustainability indices. The application of more intelligent collaborative robots, smart industrial wearables, and AI-enabled real-time monitoring of machinery and facilities offer valuable opportunities for promoting work environment safety (Bi et al., 2021; Min et al., 2019). Industry 4.0 also improves job satisfaction, given that it promotes manual labour to decision-makers or problem-solvers by supplying them with visualised information in real-time and automating exhausting and unergonomic tasks (Longo et al., 2017, 2022). Nevertheless, Industry 4.0 adversely impacts employee privacy, income equality, job security, and workplace dignity within individual businesses (Jr et al., 2022; Melé, 2021; Soh & Connolly, 2020). Under the Industry 4.0 environment, workers' psyches are constantly challenged by job insecurity, given that lower-skilled or repetitive jobs can always be lost to autonomous machines (Malik et al., 2022; Müller, 2019). The continuous and real-time monitoring feature of Industry 4.0, which can very well be extended to invasive employee monitoring, cause service privacy and security concern among employees, examples of which include unfair autonomous decisions based on monitored productivity data, excessive micromanagement, or accessing private social media content (Soukupová et al., 2020; Tong et al., 2021).

The meso-economic sustainability implications of Industry 4.0 are dominantly positive. The literature comprehensively explains how various technological constituents of Industry 4.0 can collectively improve supply chain

productivity, profitability, innovation, agility, and resilience (Fatorachian & Kazemi, 2021). Industry 4.0 draws on the integrability of big data analytics, cloud computing, CPS, and IIoT to materialise the digital supply network concept (Tsolakis et al., 2023), in which autonomy, real-time data sharing, and self-monitoring capabilities improve collaboration, decision processes, responsiveness, and productivity across supply partners (Birkel & Müller, 2021). Eligible articles further reveal that Industry 4.0 promotes supply chain resilience by supporting essential enablers like transparency, traceability, adaptability, cost-effectiveness, and continuity management (Ivanov & Dolgui, 2021; Mubarak et al., 2021). Industry 4.0 contribution to supply chain profitability involves several micro functions, such as collaborative real-time planning (Reyes et al., 2021), new service-orientated business models (Hahn, 2020), improved performance management (Xie et al., 2020), and logistics efficiency (Sun et al., 2022). Nonetheless, the digital transformation of supply chains under Industry 4.0 requires significant financial investment and reengineering of business and supply chain processes, causing temporary productivity losses (Sharma et al., 2021). Scholars also argue that the mismanagement of Industry 4.0 risk (e.g., cybersecurity) in logistics and supply chain operations has been a critical threat to supply chain productivity, profitability, and resilience (Ghadge et al., 2020; Pandey et al., 2021).

According to Fig. 3, Industry 4.0 positively impacts the majority of meso-environmental sustainability indices. For example, literature provides detailed explanations of how supply chains can draw on Industry 4.0 technologies (e.g., IoT, data analytics, or robotics) and unique features (e.g., service orientation or real-time capability) to develop circular strategies or business models such as Products-as-a-Service (PaaS) or cloud manufacturing (Mastos et al., 2021). In particular, the literature details how Industry 4.0 promotes supply chain-level intelligent waste management by addressing critical operational challenges of waste disposal and management activities such as speed, value recovery, and operating costs (Lopes et al., 2021; Zhang et al., 2021). Researchers have also shown how Industry 4.0-enabled technology intervention can optimise urban waste management systems (Kanojia & Visvanathan, 2021) and reduce value network-level pollution (Bag et al., 2021a). Although Industry 4.0 has been positively associated with supply chain sustainability, circularity, and sustainable partnership, the literature reports some negative associations in rare cases. For example, supply chain digitalisation under Industry 4.0 is challenged by the complexity of digital transformation, trust issues, and data ownership concerns (Kache & Seuring, 2017; Luthra & Mangla, 2018), which negatively impact sustainable partnerships (Pandey et al., 2021) and prevent the integration of product life cycle management into supply

chain strategies (Dolgui & Ivanov, 2020; Ghobakhloo et al., 2021a).

The literature provides controversial evidence on the implications of Industry 4.0 for meso-social sustainability. Industry 4.0 has given birth to the concept of product individualisation (Saniuk et al., 2020a), given that its underlying technologies (e.g., additive manufacturing) and design principles, such as customer integration or servitisation, provide the necessary manufacturing flexibility and cost-efficiency to produce highly individualised consumer goods (Fathi & Ghobakhloo, 2020; Leng et al., 2020). The horizontal integration and smart product features of Industry 4.0 have taken customer communication and engagement to the next level, enhancing customer satisfaction (Frank et al., 2019a, b). Nonetheless, scholars are deeply concerned about the negative impacts of Industry 4.0 on employment, job displacement, and skill crises at the supply chain or intraregional levels (e.g., Bhattacharyya & Mitra, 2020; Pardi, 2019). Industry 4.0 is radically pushing the implementation of smart technologies across supply chains, requiring employees and managers to be significantly skilled in soft computing and engineering skills such as data science (Fareri et al., 2020). As a result, most businesses struggle with upskilling issues and acquiring much-needed talents (Ayinde & Kirkwood, 2020; Mefi & Asoba, 2020). Although Industry 4.0 is creating new unheard jobs, it eliminates a significant portion of low-skilled and repetitive tasks across industrial value networks (Margherita & Braccini, 2021; Müller, 2019; Sung, 2018). Indeed, predictive models show that Industry 4.0 might displace or restructure up to 40% of jobs, intensifying employment disruption and skill discrepancy issues (Haiss et al., 2021).

Industry 4.0 can be a double-edged sword for macro-economic sustainability, as it can positively and negatively impact long-term and equitable economic growth. Scholars argue that Industry 4.0 inherently favours macro-economic growth (Ghobakhloo et al., 2021b). Nonetheless, the digital transformation of regions under Industry 4.0 has been spatially uneven, favouring peripheral regions significantly less over dynamic ones (Barzotto et al., 2020; Greef & Schroeder, 2021). Industry 4.0 promotes macroregional innovation excellence, but technologically specialised regions benefit more significantly from the digital industrial revolution (Ciffolilli & Muscio, 2018; Hilpert, 2021). Concerns regarding Industry 4.0 and unequal economic development of regions are not limited to the European region. For example, Chiengkul (2019) criticises the Thailand 4.0 agenda for intensifying Thailand's fragmented political economy and providing more advanced economic sectors with exclusive opportunities for growth under the Industry 4.0 agenda. Similarly, literature provides controversial arguments on the macro-economic impacts of servitisation, platformisation, and monopolisation pushed by Industry 4.0

(Durand & Milberg, 2020; Rainnie & Dean, 2020). Although the progressive application of disruptive Industry 4.0 technologies, such as AI or big data analytics, has been valuable to the economic and innovation growth of regions, it has adversely intensified the macro-economic inequality issues associated with intellectual monopoly capitalism and information monopoly (Durand & Milberg, 2020; Rikap, 2022), pushed mainly by tech giants (Rikap & Lundvall, 2022).

Figure 3 shows that Industry 4.0 contribution to macro-environmental sustainability indices is controversial. On a positive note, Industry 4.0 promotes macro-environmental sustainability by facilitating large-scale collaboration and partnership on environmental protection and progressing circular economy worldwide (Bai et al., 2022; Mastos et al., 2021). While Industry 4.0 combats climate change by introducing productivity and resource efficiency into industrial operations (Ghobakhloo & Fathi, 2021), the energy intensity of its underlying technologies expedites environmental deterioration (Chiarini, 2021). Digitalisation under Industry 4.0 relies on numerous infrastructural requirements, from countless hardware, battery-based storage systems, and cabling infrastructure to extensive cooling systems for data centres (Ghobakhloo & Fathi, 2021; Nara et al., 2021). These infrastructural requirements are creating an ever-increasing demand for natural resources and rare materials such as neodymium, which, in many cases, are acquired or extracted via non-environmentally friendly operations (Markard, 2020). More importantly, smarter and more electronically complex consumer goods, computer electronics used across Industry 4.0 systems, and supporting infrastructure such as cabling systems have a much shorter lifespan due to the ever-increasing innovation speed (Ching et al., 2022; Shi et al., 2020). Recycling decommissioned hardware and digital infrastructure has proven challenging and expensive, intensifying environmental degradation (Rene et al., 2021).

Industry 4.0 implications for macro-social sustainability have been primarily negative. The ever-changing distribution of jobs caused by Industry 4.0 generally increases high-wage employment while reducing lower-skilled and medium-wage occupations, raising inequality across various countries (Jr et al., 2022; Mönnig et al., 2019). While Industry 4.0 increases the prevalence of digital devices and products, the underlying income inequality and polarisation intensify the digital divide, worsening the current social exclusion crisis (Hayriye & Fatma, 2020; Wei & Peters, 2019). In addition, socio-economic digitalisation under Industry 4.0 has been associated with critical side effects, such as digital capitalism or excessive automation, which weaken social relationships and undermine the role of human agency in socio-economic values (Rikap, 2022; Xu et al., 2021). On a positive note, regional advancement in Industry 4.0 promotes digital literacy via interrelated mechanisms. Applying Industry 4.0 technologies in the education

**Fig. 4** The HF-ISM research framework

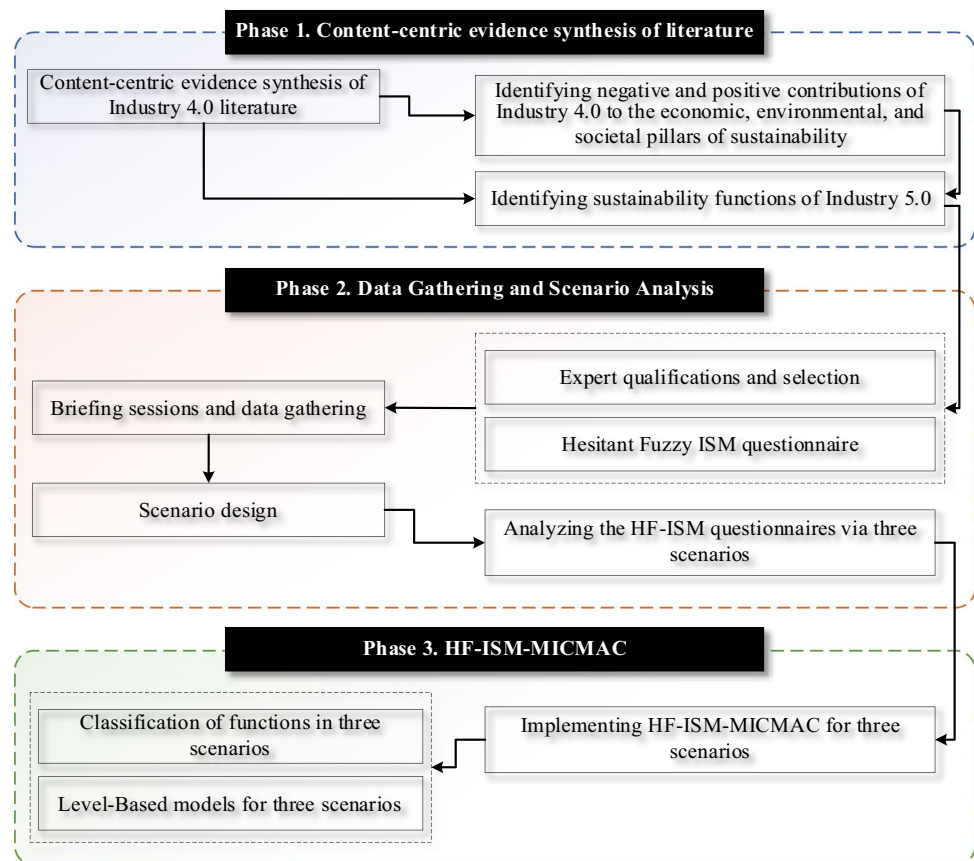

system enhances fresh graduates' digital literacy (Jamaludin et al., 2020). Alternatively, universities nowadays offer novel Industry 4.0-focused interdisciplinary programs that equip graduates with technical skills in Industry 4.0 technologies (Karre et al., 2017). Industry 4.0 also requires businesses to train their employees on the skills needed by digitalisation (Agarwal et al., 2021). Under Industry 4.0, customers must improve their digital literacy to interact better with smart products and services (Wang & Wu, 2021).

### 3 HF-ISM Methodology

To classify the functions through which Industry 4.0 promotes the sustainability goals of Industry 5.0 (from now on called Industry 4.0 sustainability functions) with different scenarios of uncertainty and to present level-based conceptual models for the relationship amongst these functions, a novel Hesitant-Fuzzy set (HFs) approach has been integrated with Interpretive Structural Modelling (ISM) known as HF-ISM. The novel approach allows experts to share their experience, intuition, and hesitation while completing the questionnaires and dealing with real-world uncertainty. Hence, this research benefits from a three-phase research framework, as shown in Fig. 4. In the first stage,

nine sustainability functions of Industry 4.0 were identified through the content-centric literature review. Afterwards, data gathering and scenario analysis were implemented based on the hesitant questionnaire used in this research. Eventually, the HF-ISM-MICMAC approach was applied to classify the functions and illustrate the level-based conceptual models. Details of the research framework have been explained in Fig. 4.

#### 3.1 Identifying Sustainability Functions of Industry 4.0

The content-centric literature review and underlying results indicate that none of the technological constituents or design principles of Industry 4.0 inherently defy sustainability priorities. Indeed, the literature acknowledges that the mismanagement of digital transformation under Industry 4.0 causes negative contributions to sustainability indices (Müller, 2020; Renda et al., 2022). Content analysis results identified nine functions through which Industry 4.0 and the underlying digitalisation, if appropriately managed, can promote various sustainability indices and fulfil the key objectives of the Industry 5.0 agenda, including environmental sustainability, human-centricity, and resilience. Notably, the *sustainability functions of Industry 4.0* refer to the practical

roles and capabilities of Industry 4.0 constituents (including technologies and design principles) in promoting sustainability. These functions represent the tangible ways that Industry 4.0 contributes to sustainable outcomes by addressing environmental, social, and economic challenges through specific actions and capabilities. It is also worth mentioning that while some of these functions may be found outside the realm of Industry 4.0, the integration of advanced technologies such as automation, artificial intelligence, the Internet of Things, and data analytics sets Industry 4.0 apart. Industry 4.0 offers a unique and unprecedented capability to deliver sustainability functions more efficiently and synergistically. The comprehensive suite of interconnected sustainability functions and the underlying technological capabilities allow Industry 4.0 to uniquely boost sustainability beyond what can be achieved with individual solutions. These functions are concisely explained in the following section.

**Business Risk Monitoring and Management (BRM)** Industry 4.0 involves developing a hyperconnected business environment where industrial control systems, IIoT, cloud technologies, and intelligent suites provide proactive and real-time-oriented monitoring of core business processes (Mishra et al., 2018). The BRM function of Industry 4.0 streamlines business operations by proactively sensing business disruptions and safeguarding mission-critical processes from technical problems (Bazan & Estevez, 2022). This function further addresses the significant shortcomings of traditional risk management through (1) removing information silos and creating an integrated risk management system, (2) predicting the dynamic impact of risk factors across various business functions, (3) forecasting the overall impact of risk management scenarios across business functions, and (4) providing a holistic real-time overview of internal and external risks (Ivanov & Dolgui, 2021; Spieske & Birkel, 2021). AI-driven predictive analytics, big data analytics, IIoT, and blockchain-driven information handling are critical enablers of BRM under Industry 4.0 (Ivanov et al., 2019). ERM contributes to sustainability by increasing the transparency of end-to-end business processes, preventing operational disruption, and improving industrial entities' environmental compliance and resource utilisation efficiency (Kazancoglu et al., 2021; Viriyasitavat et al., 2020).

**Circular Smart Products (SCP)** Industry 4.0 empowers businesses to develop products that serve the circular economy objectives by being more environmentally friendly, reusable, durable, recyclable, and, more importantly, profitable (Ertz et al., 2022). Industry 4.0 delivers the CMP function by improving value network-wide collaboration on green product development, promoting design thinking, integrating cleaner production technologies, innovating product packaging processes, and managing product end-of-life (Mubarik

et al., 2021; Saniuk et al., 2020a). CMP further involves the smartification of products and underlying services using IIoT, IIoS, cloud platforms, and AI. Smart products can be advantageous to companies, customers, and the environment, as they offer important opportunities for energy efficiency, consumption optimisation, end-of-life recovery, producer-consumer integration, product accessibility, and customer satisfaction (Bigerna et al., 2021a, b; Sallati & Schützer, 2021). Hence, CMP offers essential implications for socio-environmental sustainability concerns such as environmental degradation, pollution, and customer satisfaction or rights (Dev et al., 2020).

**Human Centred Technology Development (HTD)** This function involves developing technological products that prioritise human needs and interests (Ahmed et al., 2021). Human-centered technological products can take any form, such as applications, industrial machinery, manufacturing equipment, business intelligence system, websites, or consumer electronics (Pacaux-Lemoine et al., 2017). The HTD function promotes users' or consumers' rights, such as accessibility, privacy, or dignity (Reiman et al., 2021; Xu et al., 2021). Integrability, innovation, and virtualisation features of Industry 4.0 technologies allow businesses to understand and address users' or consumers' preferences, such as interface, skill intensity, expectations, or values (Ghobakhloo and Fathi, 2020). HTD has various implications for social sustainability concerns, such as job complexity, job security, skill gap, job displacement, customer dissatisfaction, or product accessibility (de Assis Dornelles et al., 2022). HTD also promotes the human-centricity of business operations and enhances labour productivity (Rosin et al., 2020). In particular, HTD empowers the gradual transition of manual labour to decision-makers or problem-solvers by supplying them with visualised information in real-time, along with the automation of exhausting and unergonomic tasks (Longo et al., 2017). To do so, Industry 4.0 facilitates integrating the human workforce into the hyperconnected business ecosystem (Ghobakhloo et al., 2021b). For example, industrial smart wearables such as bio-inspired protective gears would allow the human workforce to perform their tasks safer, faster, and more productively (de Assis Dornelles et al., 2022). ETA's contribution to sustainability involves promoting the users' safety, dignity, productivity, and satisfaction, to name a few (Badri et al., 2018; Rainnie & Dean, 2020).

**Operational and Resource Efficiency (ORE)** This function is bi-dimensional. It first entails drawing on Industry 4.0 technologies and design principles to improve an organisation's output-to-input ratio and increase profitability by reducing operating costs (Rosin et al., 2021). Industry 4.0 delivers this dimension of ORE via various interrelated

micro-processes. For example, virtualisation, empowered by AI, augmented reality, and digital twin technology under Industry 4.0, can boost OPE via improved financial decision processes, risk assessment acceleration, or higher system reliability (Ante, 2021). Automating repetitive tasks, effective human resource management, and improved knowledge sharing are other contributions of Industry 4.0 to operational efficiency (Margherita & Braccini, 2020). Second, Industry 4.0 improves resource efficiency by promoting technologies and business processes that favour resource productivity (Chen et al., 2021). For example, Industry 4.0 supports lean manufacturing by facilitating the continuous real-time monitoring of production operations (Reyes et al., 2021). Alternatively, Industry 4.0 technologies such as 3D printing or digital twins are crucial to implementing resource-efficient production concepts such as near-net shape or zero waste manufacturing (Ante, 2021; Kerin & Pham, 2019). Viewed holistically, Industry 4.0 allows manufacturing chains to take the life-cycle approach to introduce resource efficiency to value-creating operations, from raw material extraction and processing to product manufacturing, distribution, and consumption (Ertz et al., 2022). ORE implications for sustainability are myriad, ranging from resource consumption micro-efficiencies, human resource productivity, product quality, and industrial waste reduction to preventing environmental degradation (Mastos et al., 2021; Yilmaz et al., 2022).

**Proactive Environmentalism (PRE)** Industry 4.0 delivers *PRE* by introducing sustainability thinking into the value networks (Dev et al., 2020; Ertz et al., 2022). Through *PRE*, manufacturing chains can benefit from Industry 4.0 technologies to develop cleaner production systems and operations (Ching et al., 2022). *PRE* can also promote eco-consumerism by allowing smart consumers to understand and control the environmental impact of their consumption behaviour (Saniuk et al., 2020b). The *PRE* function draws on the integrability and data interoperability features of Industry 4.0 technology to allow value partners to integrate sustainable decision-making and meaningfully scale up a circular economy (Rajput & Singh, 2020). This function also involves enabling industrial value networks to integrate green materials and renewable energy sources into value engineering and creating processes to benefit all stakeholders from the desirable economic and socio-environmental outcomes (Scharl & Praktijnjo, 2019). Industry 4.0 delivers this functionality via several mechanisms, such as facilitating green innovation capability, decentralised decision systems, smarter energy management systems, and energy supply chain digitalisation (Ghobakhloo & Fathi, 2021). More importantly, Industry 4.0 enables the autonomous and continuous monitoring of sustainable procurement practices to promote the sustainable sourcing of raw materials (Lim et al., 2021). Climate protection, environmental degradation prevention, supply

chain-wide circularity, and renewable integration are among the sustainability outcomes of *PRE* (Cheng et al., 2021).

**Process Automation and Integration (PAI)** Industry 4.0 draws on AI, blockchain, CPS, industrial robots, control systems, and IIoT to integrate and automate intricate business processes (Margherita & Braccini, 2021). Under the smart factory concept, *PAI* involves the vertical integration of production modules and automating production lines and intralogistics operations using various technologies such as autonomous collaborative robots, automated guided vehicles, control systems, edge computing, IIoT, and execution systems (Vlachos et al., 2021). *PAI* also offers important implications for supply chain management automation, such as enabling Autonomous Storage and Retrieval Systems (ASRS) or blockchain-driven smart contracts (Viriyasitavat et al., 2020; Sun et al., 2022). Due to the horizontal integration principle of Industry 4.0, *PAI* implications extend to customer relationship management automation, including autonomous customer communication via AI-driven chatbots or customer demand forecasting via predictive analytics and business intelligence software (Libai et al., 2020). *PAI* can promote sustainability in numerous ways, such as supply chain productivity or material flow efficiency (Fatorachian & Kazemi, 2021).

**Real-Time Communication (RTC)** Real-time capability is among the integral principles of Industry 4.0 (Longo et al., 2022). The *RTC* function addresses the immediacy requirement of the contemporary business environment (Robert et al., 2022). *RTC* involves real-time data collection and analysis to facilitate immediate or near-real-time decision-making across the value network (O'Donovan et al., 2019). Under Industry 4.0, *RTC* builds on big data, cloud computing, CPS, and IoT to facilitate system integration and eliminate data silos (Roda-Sanchez et al., 2021). The scope of *RTC* expands beyond smart factories, involving other smart components of Industry 4.0, including smart suppliers, logistics, consumers, and products (Mastos et al., 2021; Robert et al., 2022). The value network-wide *RTC* function is essential to improving various sustainability indices, such as productivity, renewable integration, work environment safety, and customer satisfaction (Bag et al., 2021a; Ghobakhloo, 2020).

**Supply Chain Antifragility Capability (SCA)** Industry 4.0 delivers the *SCA* function in two major ways. First, Industry 4.0 improves supply chain responsiveness by allowing supply partners to enhance their agility, adaptability, resilience, and improvisation capabilities (Aslam et al., 2018; Eslami et al., 2021). For example, the analytical and decentralisation capabilities of Industry 4.0, thanks to AI, big data analytics, CPS, and digital twin technologies, allow supply partners

to engage in collaborative forecasting, identify weak supply chain links, build early risk detection capabilities, and achieve supply chain-wide openness to change, conditions that promote responsiveness (Gebhardt et al., 2021). Alternatively, SCA enhances the dynamism of supply chains by enabling its functional prerequisites, such as supply chain flexibility and knowledge management (Gupta et al., 2020). By doing so, Industry 4.0 empowers supply partners to gain the agility and innovativeness to implement dynamic business models that support servitisation, nearshoring, strategic adaptability, and threat conversion capabilities (Bag et al., 2021b; Ivanov et al., 2022). The literature acknowledges that SCA manifested in the dynamism and responsiveness of the supply chain is beneficial to the economic resilience aspect of sustainability at the micro and meso analysis levels (Ivanov, 2020; Kazancoglu et al., 2022).

**Sustainable Business Model Innovation (SBI)** Industry 4.0 allows businesses to apply disruptive technologies such as AI, big data, or IoT to innovate various aspects of their business model, such as value streams or customer relationships (Frank et al., 2019a, b). Businesses can also draw on Industry 4.0 to reinvent their business model entirely into new value-creation systems such as manufacturing-as-a-service (Ching et al., 2022). By doing so, companies can introduce sustainable innovation into their product or processes and stay relevant in the fast-evolving business environment (Hahn, 2020). To introduce sustainability into the business model innovation, Industry 4.0 promotes businesses' sustainable product and process innovation capabilities through a complex mechanism (Mubarak et al., 2021). Such a mechanism can be idiosyncratic to each business context yet commonly involves businesses drawing on Industry 4.0 to promote sustainable collaboration, green absorptive capacity, sustainable talent management, and sustainable innovation orientation (Ghobakhloo et al., 2021a; Liu & De Giovanni, 2019).

### 3.2 Data Gathering and Scenario Analysis

A novel, hesitant fuzzy ISM-MICMAC approach has been used to further discuss the extracted functions of Industry 4.0. To implement the design method, experts' opinion has been used for further investigations. Detailed expert identification and selection procedures were designed and implemented to ensure the reliability of experts' insights. Only European experts were targeted for this study for two major reasons. First, the present study was funded by a European project under the Horizon 2020 Research and Innovation Programme, which encouraged a European perspective on the topic. Second, Europe is the birthplace of the concepts of Industry 4.0 and Industry 5.0, and the consortia involved in this project mainly consisted of

European universities and research institutes. Accordingly, a list of 21 highly experienced experts was identified through close collaboration with the consortia partners. A self-assessment questionnaire was designed and distributed among the experts to evaluate and ensure individual experts' knowledge for participating in the study. This questionnaire measured experts' familiarity with Industry 4.0 and sustainability as well as their real-world experience concerning these concepts. As a result, according to the capabilities and accessibility, ten experts were shortlisted to participate in this research and to complete the questionnaires. The experts' profiles are presented in Table 2.

A briefing session was set for each expert for 30 min to explain the research objectives and the guidelines for completing the questionnaire (Appendix). The Hesitant Fuzzy ISM-MICMAC questionnaire is a square matrix that includes all Industry 4.0 functions in rows and columns. In each cell, the experts should respond to three questions: (i) what is the impact of function (i) on function (j)? (ii) how much is the impact possible? and (iii) how much is the impact impossible? For the first question, and according to ISM-MICMAC methodology, four options were designed and presented in Table 3.

For the second and third questions, five linguistic terms were used to determine the possibility and impossibility of each impact of function (i) over function (j) (Razavi Hajjigha et al., 2022a, b). These terms and their corresponding values are presented in Table 4 (Yalcin et al., 2020). Note that the summation of possibility and impossibility value of each cell should not exceed 1 (Dolatabad et al., 2022).

The described questionnaire was sent to each expert and was completed and gathered from all after seven weeks. Next, to analyse the completed hesitant fuzzy questionnaires, the authors designed three scenarios as follows.

- Scenario 1 (Gentle). This scenario is helpful for predictable uncertain conditions. Hence, an expert opinion is acceptable if the difference between possibility from impossibility is a positive value. Otherwise, the expert opinion is changed to the inverse value (i.e., "X" is replaced by "O," and "V" is replaced by "A" and vice versa).
- Scenario 2 (Moderate). This scenario is appropriate for moderate uncertain conditions. Hence, an expert opinion is acceptable if the possibility value is more than 50%, regardless of the impossibility value. Otherwise, the expert opinion is changed to the inverse value.
- Scenario 3 (Strict). This scenario applies to extremely uncertain conditions. Hence, an expert opinion is acceptable if the difference between possibility from impossibility is more than 50%. Otherwise, the expert opinion is changed to the inverse value.

**Table 2** Experts profile

Expert ID	Gender	Education	Experience
1	Male	Professor of innovation and sustainable development	Over 25 years of experience collaborating with various institutions, including the European Commission and World Bank, concerning digitalisation, economic development strategies, and technological innovation dynamics.
2	Female	Professor of political economy and visiting professor of sustainability leadership	20+ years of experience collaborating with various European research and policy institutions, management boards, and advisory boards concerning green technology platforms, climate mitigation, low carbon economy, and sustainable digital transformation.
3	Male	Associate professor of operations and technology management	Years of collaboration with industry concerning new technology transformation and commercialisation. Experience in more than 10 national or European-level projects concerning manufacturing smartification, sustainable manufacturing, human-centric manufacturing, and digitalisation readiness.
4	Female	Professor of entrepreneurship, innovation, and Technology	Over 20 years of experience collaborating with academia and industry concerning innovation policy, sustainable technology governance, and green innovation. Principal investigator and researcher in various European projects on digitalisation and sustainability, including Industry 4.0.
5	Male	Associate professor of industrial engineering and management	Nine years of working in the industry as a digitalisation and social responsibility consultant. Participation in various national/EU-level projects concerning Industry 4.0, climate-neutral manufacturing, sustainable energy, and circular industries.
6	Male	Assistant professor of the digital economy	Over five years of experience collaborating with various industry leaders concerning AI-driven business forecasting, smart talent management systems, and platformisation. Principal investigator or senior researcher in several national and EU-level projects on sustainable digital transportation, responsible AI, and Industry 4.0 societal disruption.
7	Female	Professor of supply chain management	Over two decades of industry experience serving as a digital supply chain consultant. Years of experience high-level policy expert in various European policy groups or projects concerning complex system design for sustainability, sustainable digital transformation, and societal development.
8	Male	Distinguished professor of smart manufacturing	Over 20 years of experience working with small to large manufacturing firms as a consultant and research partner on smart manufacturing, robotic and computer-integrated manufacturing, assisted operators, digital twinning of manufacturing systems, and digitalisation upskilling. Involvement in numerous research and innovation projects concerning Industry 4.0, smart factories, sustainable manufacturing, circular manufacturing, and cleaner production technologies.
9	Female	Professor of environmental policy	Close to three decades of collaboration with public policy institutions and industry concerning digital industrial transformation, environmental policy, and sustainable development. Senior researcher, advisory board member, or activist at high-level policy bodies responsible for policies and practices in sustainable development within Europe.
10	Male	Associate professor of digital supply chain innovation	Involvement in a few European projects on sustainable supply chain digitalisation strategies, Industry 4.0 innovation, autonomous decision systems, supply chain responsiveness, and circular supply chain. Industry involvement as supply chain digitalisation and sustainable innovation consultant.



**Table 3** Expressions evaluating the relations of criteria (Jafari-Sadeghi et al., 2021)

Sign	Description
V	The function (i) leads to function (j)
A	The Function (j) leads to function (i)
X	There is a two-way relationship between function (i) and function (j)
O	There is no relationship between function (i) and function (j)

**Table 4** The value of each linguistic term for the Hesitant Fuzzy questionnaire

Possibility		Impossibility	
Term	Value	Term	Value
Not possible	0	Not impossible	0
Nearly possible	0.25	Nearly impossible	0.25
Fairly possible	0.5	Fairly impossible	0.5
Very possible	0.75	Very impossible	0.75
Absolutely possible	1	Absolutely impossible	1

### 3.3 Hesitant Fuzzy ISM-MICMAC

After extracting the functions of sustainable Industry 4.0 and data gathering and scenario design, the questionnaire is all completed for further investigation. Thus, the HF-ISM-MICMAC approach is implemented to classify the functions in three scenarios and illustrate a level-based conceptual model to demonstrate the relationship between functions. The preliminaries and definitions required for this section are described as follows.

It is widespread and reasonable for participants to employ linguistic terms to share their experience and intuition and decide on the extracted functions' importance accordingly. In most cases, uncertainty occurs when the weight of a function or element, the importance of the expert's opinions, and the value of variables are stated with linguistic terms (Razavi Hajiagha et al., 2022a, b). Cognitive concepts are assumed and supposed as an approach to deal with this issue. This often happens when the element is subjective or limited numerical data exists. Uncertainty undeniably impacts the decision-making process; hence, it should be considered in this research (Mushtaq et al., 2011). For decades, fuzzy sets and their developments have been applied as a suitable approach to consider uncertainty and ambiguity, where each approach studies uncertainty differently (Amoozad Mahdiraji et al., 2023). Zadeh introduced fuzzy sets to deal with uncertainty in 1965. Since then, numerous developments of fuzzy sets have been illustrated, such as intuitionistic fuzzy sets (Atanassov, 1986), type 2 fuzzy sets

(Rickard et al., 2008), and z-numbers (Zadeh, 2011). Hesitant fuzzy sets were designed in 2009 (Torra & Narukawa, 2009) to solve the problem of determining the membership of an element in the case that there is doubt, as illustrated by two experts. In this article, three scenarios of uncertainty, including extremely uncertain (strict), moderate uncertain (moderate) and predictable uncertain (gentle), were designed and adopted to investigate the extracted functions (described in Section 3.2). Hence, hesitant fuzzy sets and values (as described in Table 4) were necessary to consider the uncertainty of the environment and embed the experts' intuition and experience during the evaluation of functions in different scenarios. Two basic definitions for hesitant sets are as follows.

**Definition 1.** Let  $X$  be a reference set, a hesitant fuzzy set on  $X$  is defined in the term of a function  $h$  that returns a subset of  $[0, 1]$  when applied to  $X$ .

**Definition 2.** Let be a hesitant fuzzy set, the lower bound, upper bound, and complement of is defined as Eqs. 1 to 3.

$$h^-(x) = \min h(x) \quad (1)$$

$$h^+(x) = \max h(x) \quad (2)$$

$$h^c(x) = \bigcup_{\gamma \in h(x)} \{1 - \gamma\} \quad (3)$$

#### 3.3.1 Interpretive Structural Modelling

ISM is one of the methods for analysing the relationships between elements, classifying them, and designing a level-based conceptual model. This method is popular among scholars and has been widely employed (Hashemi et al., 2022). In tackling complex problems, ISM-MICMAC has emerged as a leading tool, offering several distinct advantages over comparable methodologies. Research has shown that ISM-MICMAC is versatile and flexible, providing researchers with a comprehensive framework for analysing complex systems and making better decisions. (Jafari-Sadeghi et al., 2021). In this methodology, complex systems are broken down into smaller subsystems. A multilevel structural model enables individuals and groups to understand the relationships that underlie difficult situations (Iqbal et al., 2023). It then uses the experts' practical expertise and knowledge to map the many elements of a given case. By using ISM-MICMAC, it is possible to understand the interaction of each system component within a broader context by breaking it down into smaller subsystems. The ISM-MICMAC methodology offers a significant benefit in that it enables the examination of both direct and indirect interrelationships between variables, thereby facilitating the

analysis of the dynamic impact of various elements (Khaba et al., 2021). Traditional ISM considers only binary digits to indicate whether variables are connected. Consequently, it did not capture the strength of the relationship between the functions and cannot investigate different scenarios in ambiguous environments. The Hesitant Fuzzy ISM-MICMAC methodology addresses this problem. This approach facilitates a more comprehensive comprehension of the interrelationships between variables (Mahdiraji et al., 2021). Existing studies have demonstrated its potential for analysing complex systems and identifying the most critical factors in various cases.

**Step 1.** A structural self-interaction matrix is formed by employing experts' opinions. In this regard, each expert determines the pairwise relationship between the functions  $i$  and function  $j$ , found in the expressions presented in Table 3. Here, three rules of scenarios designed in stage 2 should be applied to determine the value of each cell.

**Step 2.** The initial reachability matrix is designed based on the expressions of Table 3 and scenario rules. Therefore, for X and V, the value of one, and for A and O, zero was replaced for each expert (Iqbal et al., 2021). Then the average amount of each cell amongst the experts was measured (by arithmetic mean), and an integrated matrix was extracted. If the arithmetic means the value was greater than or equal to 0.7, then the value of one was used; otherwise, zero.

**Step 3.** Transitivity Check. The general rule is that if function  $i$  leads to  $j$  and function  $j$  leads to  $k$ , then function  $i$  leads to  $k$ . This rule should be tested for all possible situations, and the value of 1\* should be replaced for all zero values if this rule applies (Jafari-Sadeghi et al., 2021). The result is known as the final reachability matrix. This step is important to reinforce the conceptual coherence of the initial reachability matrix and fill any gaps between the functions.

**Step 4.** Equations (4) and (5) computed the driving and dependence power of each function.

$$\text{Driving Power} = \sum_{i=1}^n r_{ij} \quad (4)$$

$$\text{Dependence Power} = \sum_{j=1}^n r_{ij} \quad (5)$$

Notice that in Eqs. (4) and (5),  $r_{ij}$  is the impact (zero or one) of function  $i$  on function  $j$ . In addition,  $n$  is the total number of functions (nine in this research).

**Step 5.** Next to the formation of the final reachability matrix (FRM), designing a level-based conceptual model that presents the relationship amongst the Industry 4.0 functions was considered. Hence, for each function, the

outputs (values of one in the row) are known as the reachability set, inputs (values of one in the column) are known as an antecedent set, and the intersection sets (values of one in both columns and row) are specified. Then, in each level, functions with equal intersection and antecedent sets were excluded from the analysis and considered a level. The same logic is repeated for all other functions (Jafari-Sadeghi et al., 2021). Accordingly, the level-based conceptual model of the functions was designed.

### 3.3.2 MICMAC Analysis

ISM is mainly used in conjunction with a criterion analysis technique called MICMAC. This analysis was presented in 1973 by Dugreen and Goodet. The purpose of this analysis is to categorise the criteria based on their effectiveness into four categories of elements, including (i) autonomous (low driving and dependence power), (ii) drivers (high driving and low dependence power), (iii) dependent (low driving and high dependence power), and (iv) linkage (high driving and dependence power) according to Eqs. (4) and (5) (Dhir & Dhir, 2020).

## 4 Results

The results were achieved by implementing the research method on the gathered data. Hence, according to the scenarios in Section 3, three classifications of Industry 4.0 functions and three level-based conceptual models were extracted. First, by applying the three scenarios on the completed questionnaires and measuring the arithmetic mean of the cells, the initial reachability matrices of all three scenarios resulted in Table 5.

Next, by applying the transitivity analysis (step 3, stage 3) and measuring the driving and dependence power via Eqs. (4) and (5) (step 4, stage 3), the final reachability matrix for each scenario emanates as Table 6.

By applying the results of Table 6 in the MICMAC analysis, the classified versions of the Industry 4.0 functions are presented in Fig. 5 (x-array driving power and y-array dependence power). This classification illustrates the (i) autonomous (low driving and dependence power), (ii) drivers (high driving and low dependence power), (iii) dependent (low driving and high dependence power), and (iv) linkage (high driving and dependence power) functions studied in this research in three scenarios.

After classifying the Industry 4.0 sustainability functions, using ISM methodology step 5, all functions were levelled in each scenario, and a conceptual framework was emanated. The results are demonstrated in Fig. 6. Remark that, for the gentle scenario, only two levels were engendered, including  $F_7$  as the driver and first level, and the rest

**Table 5** Initial Reachability Matrix (IRM) for gentle, moderate, and strict scenarios

Functions	F1	F2	F3	F4	F5	F6	F7	F8	F9
Code	Abbreviation								
F1	Scenario 1. Gentle								
F1	1	0	0	1	0	0	0	1	1
F2	0	1	0	1	0	1	0	0	0
F3	0	0	1	0	0	1	0	0	0
F4	0	0	0	1	0	0	0	1	0
F5	0	1	0	0	1	0	0	0	1
F6	1	1	0	1	1	1	0	1	0
F7	1	1	1	1	1	1	1	1	0
F8	0	0	0	0	0	0	0	1	0
F9	0	1	1	1	1	0	0	1	1
F1	Scenario 2. Moderate								
F1	1	0	1	1	0	0	0	1	1
F2	0	1	1	0	0	0	0	0	0
F3	0	1	1	0	0	1	1	1	0
F4	0	0	0	1	0	0	0	1	0
F5	0	0	1	0	1	1	0	0	0
F6	0	0	1	1	0	1	0	1	0
F7	0	1	0	0	1	1	1	0	1
F8	0	1	1	0	0	0	1	1	0
F9	1	1	1	0	0	1	1	0	1
F1	Scenario 3. Strict								
F1	1	0	1	0	0	0	0	0	1
F2	0	1	1	0	0	0	0	0	0
F3	0	1	1	0	0	0	1	1	0
F4	1	1	1	1	0	0	1	1	1
F5	0	0	1	0	1	1	0	0	0
F6	0	0	0	1	0	1	0	0	0
F7	0	1	0	0	1	1	1	0	1
F8	0	1	1	0	0	0	1	1	0
F9	1	0	1	0	0	0	1	0	1

**Table 6** Final reachability matrix and driving and dependence power of each function

Function	F1	F2	F3	F4	F5	F6	F7	F8	F9	Driving power	Dependence power
Scenario 1. Gentle											
F1	1	1	1	1	1	0	0	1	1	7	5
F2	1	1	0	1	1	1	0	1	0	6	7
F3	1	1	1	1	1	1	0	1	0	7	5
F4	0	0	0	1	0	0	0	1	0	2	8
F5	0	1	1	1	1	1	0	1	1	7	7
F6	1	1	0	1	1	1	0	1	1	7	6
F7	1	1	1	1	1	1	1	1	1	9	1
F8	0	0	0	0	0	0	0	1	0	1	9
F9	0	1	1	1	1	1	0	1	1	7	5
Scenario 2. Moderate											
F1	1	1	1	1	0	1	1	1	1	8	3
F2	0	1	1	0	0	1	1	1	0	5	9
F3	0	1	1	1	1	1	1	1	1	8	9
F4	0	1	1	1	0	0	1	1	0	5	7
F5	0	1	1	1	1	1	1	1	0	7	5
F6	0	1	1	1	0	1	1	1	0	6	8
F7	1	1	1	1	1	1	1	1	1	9	9
F8	0	1	1	0	1	1	1	1	1	7	9
F9	1	1	1	1	1	1	1	1	1	9	5
Scenario 3. Strict											
F1	1	1	1	0	0	0	1	1	1	6	5
F2	0	1	1	0	0	0	1	1	0	4	9
F3	0	1	1	0	1	1	1	1	1	7	9
F4	1	1	1	1	1	1	1	1	1	9	4
F5	0	1	1	1	1	1	1	1	0	7	6
F6	1	1	1	1	0	1	1	1	1	8	7
F7	1	1	1	1	1	1	1	0	1	8	9
F8	0	1	1	0	1	1	1	1	1	7	8
F9	1	1	1	0	1	1	1	1	1	8	7

of the functions as the second level. Hence, this scenario is not presented in Fig. 6.

### 5 Discussion

The present study identified nine functions through which Industry 4.0 if appropriately governed, can contribute to the sustainability objectives of the emerging Industry 5.0 agenda. These nine functions were identified as business risk monitoring and management (BRM), human-centred technology development (HTD), operational and resource efficiency (ORE), process automation and integration (PAI), proactive environmentalism (PRE), real-time communication (RTC), sustainable business model innovation (SBI), supply chain antifragility capability (SCA), and smart circular products (SCP). A novel HF-ISM approach was developed and implemented to identify the underlying mechanism

for the contribution of Industry 4.0 to sustainability via these functions and under real-world circumstances. The application of these functions identified three scenarios that uniquely define how the sustainability functions of Industry 4.0 may interact under a specific business circumstance.

Scenario 1 concerned a real-world business environment with predictable uncertainty, and experts could confidently and accurately predict the existing environmental uncertainties. Under this scenario, SBI acts as the most driving function, simultaneously empowering the other eight functions of Industry 4.0 to interact and contribute to the sustainability goals of Industry 5.0. This scenario takes the innovation capabilities of Industry 4.0 for granted, postulating that Industry 4.0 and the industrial application of its digital technologies autonomously and inherently empower sustainable innovation. Under this scenario, SBI allows the other eight functions of Industry 4.0 to be developed and capitalised on simultaneously to promote sustainability

**Fig. 5** **a** Classification of Industry 4.0 functions in the gentle scenario. **b** Classification of Industry 4.0 functions in the moderate scenario. **c** Classification of Industry 4.0 functions in the strict scenario

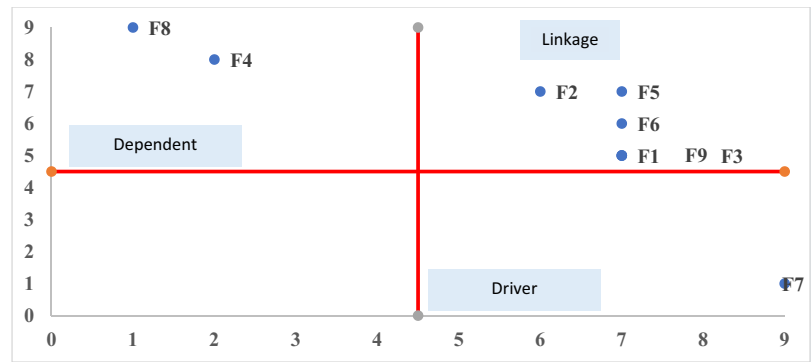

**a** Classification of Industry 4.0 functions in the gentle scenario.

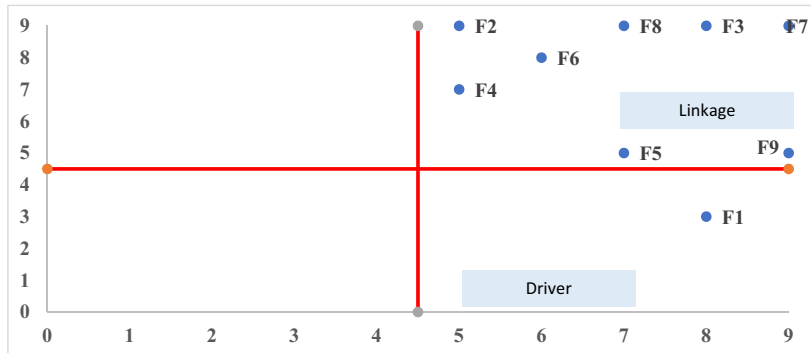

**b** Classification of Industry 4.0 functions in the moderate scenario.

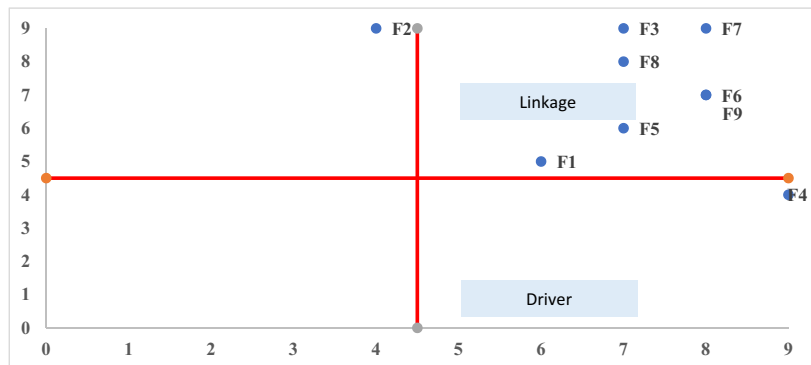

**c** Classification of Industry 4.0 functions in the strict scenario.

objectives synergistically. While the enabling role of digitally empowered sustainable business model innovation for functions such as ORE and SCP is well documented within the literature (e.g., Fernando et al., 2019), this scenario contradicts the recent findings regarding the sustainable innovation mechanism and sustainability performance of Industry 4.0. Indeed, this scenario contradicts Ghobakhloo et al.'s (2021a) findings, which demonstrated that sustainable innovation capability is among the most hard-to-develop benefits of Industry 4.0 that depends on various digitally-enabled sustainability functions such as green absorptive capacity, sustainable innovation orientation, and inter-functional collaboration. We consider scenario one the least feasible since the contemporary business world is constantly challenged by ever-increasing disorders such as socio-political

conflicts, generational changes, and data commoditisation. We acknowledge that sustainable innovation can be recognised as one of the core design principles of Industry 4.0 under an ideally deterministic business environment. Nonetheless, firms' motive for adopting Industry 4.0 technologies mainly concerns functions that boost corporate survivability under turbulent business environments. It means scenario 1, emphasising the predominating role of the SBI, is more likely to lack applicability to the turbulence and unpredictability of today's business world.

Scenario 2 concerns the implications of Industry 4.0 for the sustainability goals of Industry 5.0 in a business environment where uncertainty is somewhat unpredictable, and experts can cautiously predict the existing environmental uncertainties. Under this scenario, Industry 4.0 contribution

**Fig. 6** The level-based conceptual framework for the functions

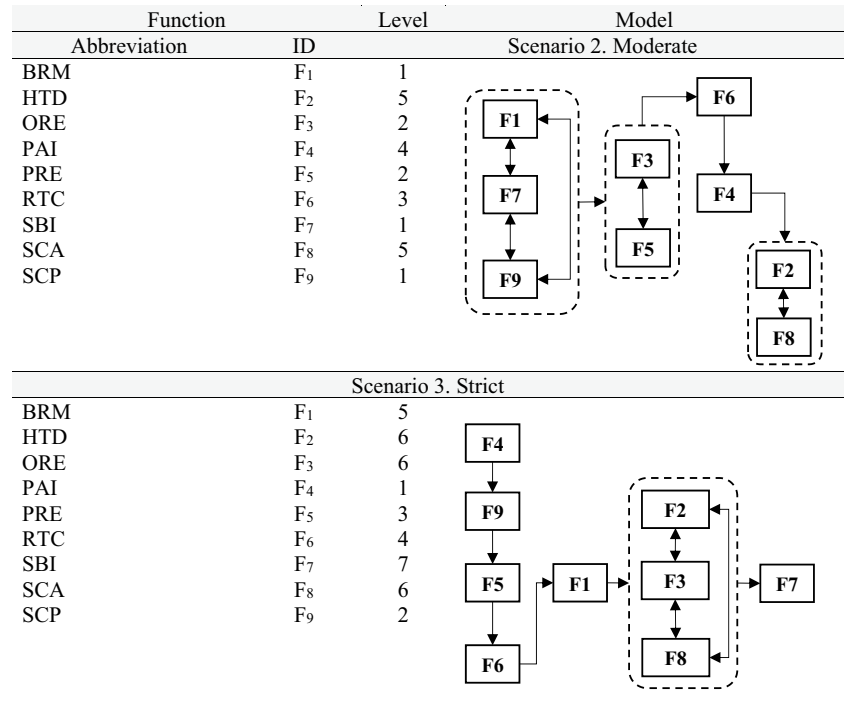

to sustainability first involves the simultaneous improvement of business risk management, sustainable innovation management, circularity, and product smartification capabilities of businesses via BRM, SBI, and SCP functions. Since BRM, SBI, and SCP are positioned at the same placement level within the interpretive model of scenario 2, it is safe to assume that these functions complement and synergically boost each other while enabling other sustainability functions of Industry 4.0. Indeed, these functions collectively enable ORE and PRE, positioned at placement level 2 of scenario 2's interpretive model. ORE and PRE, in turn, empower real-time communication within the industrial value networks (the RTC function). The interpretive model for this scenario further explains that RTC allows businesses to automate and integrate their processes (the PIA function), paving the way for developing more human-centric technologies within the business environment (the HTD function) and building more antifragile supply chains (the SCA function). Overall, scenario 2 implies that Industry 4.0 inherently empowers more sustainable business models under moderate business unpredictability. Nonetheless, Industry 4.0 draws on its risk management and sustainable product smartification capabilities to address the uncertainties associated with introducing sustainable innovation into business models. Contrary to scenario 1, where SBI would supposedly allow all the other sustainability functions of Industry 4.0 to emerge contemporaneously, specific precedence relationships exist between the functions under scenario 2. In this scenario, SBI, BRM, and SCP functions empower sustainability-driven resource productivity, which in turn, provides

businesses with the necessary resources and capabilities to achieve real-time communication within and across business operations. The real-time capability further facilitates the PIA function by enhancing the efficiency of intelligent automation tools for highly complex operations. Under this scenario, HTD and SCA are the most hard-to-develop sustainability functions since they can only become operational after developing other sustainability functions.

Scenario 3 concerns the business environment in which uncertainty is very unpredictable, and experts cannot make accurate and confident predictions of the existing environmental uncertainties. We believe that scenario 3 is the most realistic at the time of this study, considering the ongoing war in Ukraine, the energy crisis in Europe, and the lingering disruption effect of the COVID-19 pandemic. Under this scenario, Industry 4.0 contribution to the sustainability objectives of the Industry 5.0 agenda first entails integrating and automating business processes via the PAI function. The benefits and integration capabilities gained from PAI allow businesses to develop smart products that empower circular manufacturing by integrating customers and enhancing product life cycle management (the SCP function). SCP, in turn, empowers businesses to develop and implement proactive environmental strategies (the PRE function) by providing a bird's-eye view of product life-cycle and consumer behaviour. The interpretive model for scenario 3 reveals that under the unpredictability of environmental uncertainties, PRE is a prerequisite to developing real-time capabilities. This observation challenges the mainstream

literature widely proposing that RTC is a technical function that is mainly empowered by decentralisation or interoperability features (e.g., O'Donovan et al., 2019). This unorthodox observation implies that when severe unpredictability applies, developing real-time capabilities in the business environment relies on firms' ability to develop forward-thinking strategic behaviour in proactively dealing with emerging uncertainties. Under scenario 3, RTC is the critical enabler of business risk monitoring and management capabilities (BRM). The implications of RTC for BRM may involve higher supply network visibility or real-time identification of risk factors. Despite the considerable dependence power of BRM, this function plays a critical driving role under scenario 3, as it directly facilitates business antifragility, technologic human-centricity, and industrial efficiency (the HTD, ORE, and SCA functions). In this scenario, SBI is the most hard-to-develop function of Industry 4.0, relying on the synergistic complementarities among HTD, ORE, and SCA.

Scenario 3 fundamentally challenges scenario 2, demonstrating that Industry 4.0 does not inherently favour sustainable business innovation under unpredictable uncertainties. To put it differently, process automation and achieving vertical and horizontal integration are the primary reasons businesses operating in volatile and unpredictable environments commit to Industry 4.0 digital transformation. This observation is somewhat expected, given that businesses need to automate their processes, integrate with stakeholders, build risk management capabilities, and enjoy resource efficiency to have the liberty to innovate their business models sustainably under unpredictable uncertainties.

The present study adopted a business-oriented perspective to explore the potential opportunities that purposeful governance of Industry 4.0 could provide for sustainability. While acknowledging the crucial role of business partners in achieving the sustainability objectives of Industry 5.0, we also recognised the insights from a recent study by Ghobakhloo et al. (2023a) that highlighted the significance of stakeholders, including governments and social actors, in guiding Industry 4.0 towards the sustainability goals of Industry 5.0. However, it is essential to note that the scope of the present study primarily focused on investigating the critical enabling role of businesses within this ecosystem. Our findings complement the recent work by Ghobakhloo et al. (2023a), as they shed light on the extensive scope of Industry 4.0 governance that extends beyond the realm of businesses alone. While Ghobakhloo et al. emphasised the importance of various stakeholders in steering Industry 4.0 towards sustainability, our study provides additional insights that further elucidate the multifaceted nature of governance within the Industry 4.0 landscape.

## 6 Implications

The present study addressed the knowledge gaps concerning the transformation from Industry 4.0 to Industry 5.0. The study strived to explain why Industry 5.0 is being rushed in such an unprecedented manner and how the ongoing digital industrial transformation known as Industry 4.0 should be managed to fulfil the sustainability objective of the Industry 5.0 agenda. To this purpose, the study implemented a unique methodology that involved the content-centric evidence synthesis of the literature and the development of a novel HF-ISM approach. The results are believed to provide important contributions to knowledge and practice. These implications are concisely discussed in the following.

### 6.1 Theoretical Implications

The results of the content-centric literature review reveal that Industry 4.0's contributions to sustainability are controversial. Industry 4.0 is a technology-push and productivity-driven phenomenon. As expected, Industry 4.0 implications for micro and meso economic sustainability have been dominantly positive, meaning digital industrial transformation under Industry 4.0 has led to substantial productivity improvement at the corporate and supply network levels. In rare cases, the negative impact of Industry 4.0 on the economic pillar of sustainability has been reported within the literature. Nonetheless, negative impacts have been mostly identified as temporary and rooted in the disruption caused by the implementation of Industry 4.0 disruptive technologies. Similarly, results imply that the micro and meso environmental sustainability implications of Industry 4.0 have been dominantly reported as positive. Indeed, the literature has identified various techno-functional principles of Industry 4.0 that improve energy consumption, waste aversion, circularity, emission reduction, and green innovation at the corporate and supply network levels. Conversely, the implication of Industry 4.0 for micro and meso-social sustainability is controversial and inconclusive. For example, the literature offers mixed results regarding how Industry 4.0 technologies impact job complexity. In addition, while Industry 4.0 has enhanced job safety or customer satisfaction, it has been dominantly detrimental to employee privacy, job security, and job displacement. Scholars justify these controversies by arguing that none of the technologies or principles of Industry 4.0 has been pushed by or designed for social values.

The results further reveal that the macro sustainability impacts of Industry 4.0 are understudied and inconclusive.

While Industry 4.0 offers positive implications for innovation growth and digital literacy, it has largely been detrimental to equitable macro-regional economic development, social equality, rebound effect, and job polarisation. Overall, our findings imply that Industry 4.0 has not been instrumental in addressing many of the long-lasting sustainability concerns. Many critical socio-economic sustainability concerns have been intensified due to the radical and somewhat unregulated emergence of Industry 4.0 disruptive technologies. We believe these findings adequately explain why the Industry 5.0 agenda is being pulled by socio-political bodies such as the European Commission. It is imperative to note that contemporary literature struggles with recognising Industry 5.0 as a new technology-driven industrial revolution superseding Industry 4.0. As a socio-politically pushed agenda, Industry 5.0 emphasises the role of collective and stakeholder-centered governance of digital industrial transformation pushed by Industry 4.0. This agenda proposes that corporations and social actors should collaboratively govern and regulate Industry 4.0 transformation to ensure that socio-environmental goals are valued as highly as industrial productivity. Consistently, our findings reveal that underlying technologies and design principles of Industry 4.0 do not intrinsically contradict social values. Nevertheless, the profit-centred digital transformation management under Industry 4.0 has adversely impacted the environment and society during the past decade. In addition, our literature review has unveiled a noteworthy trend where recent studies leverage the disruptive emergence of generative artificial intelligence within the scope of Industry 5.0 to suggest that Industry 5.0 might constitute the next wave of the industrial revolution. In light of this, our study underscores the perspective that Industry 5.0 should be recognized as a socio-technological transformation framework. Indeed, the Industry 5.0 framework involves the responsible utilization of emerging Industry 4.0 technologies to integrate societal values into companies' digital transformation strategies.

Accordingly, our literature synthesis identified various functions through which the responsible utilization of Industry 4.0 technologies can potentially promote the sustainability values of Industry 5.0. Each of the functions identified offers narrow implications for a few specific aspects of Industry 5.0 sustainability goals. For example, the PAI function of Industry 4.0 has been consistently reported to promote the waste reduction, resource consumption efficiency, and business resilience aspects of sustainability. Building on the consensus that 'if governed appropriately, Industry 4.0 can promote the sustainability values prioritised under the Industry 5.0 agenda,' we developed and implemented a novel HF-ISM approach that identified how the sustainability functions of Industry 4.0 should contextually interact to fulfil Industry 5.0's sustainability values.

Finally, the study contributes to the literature by revealing that while Industry 5.0 sets ambitious sustainability goals, the methods to achieve them are largely unclear. Findings showed that Industry 5.0 builds upon the technologies and principles established in Industry 4.0. Consequently, companies can strategically harness the sustainability features embedded in Industry 4.0 to contribute to the societal objectives of Industry 5.0 systematically. This insight enhances our understanding of how Industry 4.0 technologies and principles can be methodically applied to bridge the gap between sustainability aspirations and the practical implementation of the Industry 5.0 framework.

## 6.2 Practical Implications

Our HF-ISM approach identified three scenarios under which the sequential interaction of the sustainability functions of Industry 4.0 differs significantly. In a less turbulent environment where uncertainties are precisely predictable, Industry 4.0 inherently allows organisations to introduce innovation into their business model sustainably, allowing other sustainability functions of Industry 4.0 to flourish collectively. As unanimously emphasised by the expert panel, this scenario is naively optimistic and may lack applicability to the realities of the turbulent business world. Indeed, scenario one would be most applicable to businesses operating in mature industries, particularly older and stable mega corporations that have the necessary resources to leverage the business innovation opportunities of Industry 4.0 to enable and capitalise on other sustainability functions simultaneously.

Under scenario two, where uncertainties of the business environment are reasonably predictable, Industry 4.0 stakeholders should strive to leverage BRM, SBI, and SCP functions simultaneously to introduce innovation into business models sustainably, promote smart products that support circularity, and monitor the associated processes and risks. These functions will further empower businesses to proactively implement sustainability strategies and enjoy higher operational and resource efficiency. Under moderate business uncertainties in this scenario, real-time communication capability (RTC function) is moderately imperative yet critical for enabling process automation and integration. Under scenario 2, human-centric technology development and supply chain agility are dependent functions and should be leveraged when other enabling sustainability functions of Industry 4.0 are already in place. Therefore, this scenario assumes that antifragility and human-centricity may not be critical to other sustainability functions and can be considered the most remote and less critical (in terms of relational importance) sustainability outcomes of Industry 4.0.

Under the third scenario, we identified how Industry 4.0 could best serve the sustainability values of Industry 5.0



under an extremely turbulent environment where uncertainties are highly unpredictable. Under such circumstances, businesses should first leverage the automation and integration capabilities of Industry 4.0 to strengthen their competitive position via higher cost savings and productivity. Industry 4.0 stakeholders should draw on the SCP function to develop and integrate smart products that facilitate circularity by drawing on the integration capabilities gained from the PAI function. This sequence of leveraging Industry 4.0 functions should continue by implementing more proactive environmental strategies and drawing on Industry 4.0 technologies and capabilities that support real-time communication within the business network. Under extreme uncertainties, real-time communication capability is indispensable to the business process and risk monitoring function of Industry 4.0, given that changes and disruptions in the internal and external business environment could happen unexpectedly. Scenario 3 emphasises the crucial role of BRM, introducing this function as the critical requirement for HTD, ORE, and SCA functions of Industry 4.0. These three functions are co-dependent under highly unpredictable uncertainties, and Industry 4.0 stakeholders should strive to synergistically leverage the human-centric technology development, antifragility, and industrial efficiency functions of Industry 4.0. Adhering to this sequence would eventually empower businesses to effectively benefit from the sustainable innovation capabilities of Industry 4.0 to innovate their business model in line with the sustainability values of Industry 5.0. We believe scenario 3 to be more realistic for businesses operating under a highly turbulent environment, particularly businesses impacted by regional conflicts like the Russian invasion of Ukraine.

Overall, the findings of our study have significant implications for organisations aiming to leverage Industry 4.0 to enhance their sustainability efforts. While the identified scenarios shed light on the sequential interaction of sustainability functions, providing actionable pointers on how businesses can effectively capitalise on these functions is crucial. The following offers specific guidance for managers to consider when devising digitalisation governance strategies in various environmental contexts:

*For scenario one* and under Less Turbulent Environment with Predictable Uncertainties, an opportunity exists for businesses in mature industries, particularly older and stable mega-corporations, to introduce sustainable innovation into business models using disruptive technological constituents of Industry 4.0 such as digital twin and AI. To fully leverage this potential, organisations should focus on the following actionable pointers:

- Allocate necessary resources to capitalise on business innovation opportunities presented by Industry 4.0 technologies.

- Simultaneously enable and capitalise on other sustainability functions to maximise the collective impact.
- Consider the specific needs and capabilities of the organisation in leveraging sustainability outcomes.

*For scenario two* and under a Moderately Predictable Business Environment where uncertainties are reasonably predictable, organisations should strive to simultaneously leverage the BRM, SBI, SCP, and RTC and consider the following actionable pointers consecutively:

- Emphasise sustainable innovation in business models by integrating BRM, SBI, and SCP functions.
- Promote circularity by developing and integrating smart products while monitoring associated processes and risks.
- Leverage RTC capabilities to enable process automation and integration, focusing on operational and resource efficiency.
- Prioritise human-centric technology development and supply chain agility in alignment with other sustainability functions.

*For scenario three* and under a Highly Turbulent Environment with Unpredictable Uncertainties, organisations operating in extremely uncertain contexts should prioritise strengthening their competitive position through cost savings and productivity gains by leveraging the automation and integration capabilities of Industry 4.0. To effectively navigate such turbulent environments, managers should consider the following actionable pointers:

- Utilise the PAI function to integrate and automate business processes, enhancing competitiveness.
- Develop and integrate smart products that support circularity using the SCP function.
- Implement proactive environmental strategies and leverage real-time communication capabilities to monitor and respond to unexpected changes and disruptions.
- Establish BRM as a critical requirement for HTD, ORE, and SCA functions to maximise their synergistic effects.

Managers should note that the three scenarios can be equally applicable depending on the firm's internal environment (e.g., culture, processes, resources) and external environment (e.g., regions' socio-political and economic circumstances). It is vital for managers to also bear in mind that the driving and dependence power of these functions and their placement levels within the interpretive models of the scenarios do not reflect their absolute importance concerning the sustainability values of Industry 5.0. The sequential orders identified within the scenarios merely reflect the precedence relationships that might exist within the functions.

Under a given scenario, the sequential order for leveraging the functions is expected to maximise the synergistic values of the functions for sustainability objectives. Regardless of the scenarios, each identified function uniquely promotes some aspects of Industry 5.0 sustainability values. Hence, none of these functions and their enabling role can be overlooked while devising Industry 4.0 governance strategies.

## 7 Conclusion

The present study addresses the existing knowledge gaps surrounding the transition from Industry 4.0 to Industry 5.0 while focusing on sustainability values. The findings highlight the controversial nature of Industry 4.0's contributions to sustainability. The study emphasises the importance of collective governance and regulation to prioritise socio-environmental goals alongside industrial productivity. Moreover, the novel HF-ISM approach developed in this study identifies distinct scenarios for effectively leveraging the sustainability functions of Industry 4.0 to align with the sustainability values of Industry 5.0 in different levels of environmental uncertainties. Nonetheless, the results should be interpreted in light of the study's limitations.

### 7.1 Limitations and Future Directions

Despite our efforts to ensure the reliability and inclusivity of our findings, the present study inevitably faces some limitations that future studies can address. Scholars believe that Industry 4.0 is dynamic and far from its full potential. Likewise, the Industry 5.0 agenda is embryonic and expected to evolve significantly in the future. It means the sustainability values of Industry 5.0 will expectedly evolve, and the functionality of Industry 4.0 to satisfy these values may change accordingly. Therefore, our methodology and the novel HF-ISM approach can be used as a baseline for future studies to evaluate the sustainability implications of Industry 4.0 in the future and under various business scenarios with varying predictability of uncertainties.

The second limitation of this study concerns the non-probability nature of the sample consisting of 21 experts. The purposeful selection of experts based on their expertise and experience introduces potential biases and restricts the generalisability of the findings. Caution should be exercised when extrapolating the results beyond the specific sample of experts included in this study. Future research employing probability sampling methods could enhance the representativeness of the findings and allow for broader generalisations. Despite this limitation, the study provides valuable insights within the context of the sampled experts, serving as a foundation for further research in the field.

Third, the interpretive models identified in this study merely describe the order in which the sustainability functions of Industry 4.0 should be leveraged to maximise their sustainability values synergistically. Although Industry 4.0 can offer valuable sustainability functions, these functions are complex and resource-intensive. We must acknowledge that digitalisation under Industry 4.0 does not guarantee the automatic development of these desired functions. Indeed, several industrial cases within the literature argue that using Industry 4.0 technologies to achieve operational and resource efficiency in factories is a complicated, resource-intensive, granular, and high-risk process, which may rely on several success factors such as knowledge competencies, information and operations technology readiness, change management capabilities, and technology governance competencies. Since identifying the micro-mechanisms through which Industry 4.0 can successfully deliver these sustainability functions fall outside the scope of the present work, we invite future research to identify, explore, and scrutinise these micro-mechanisms.

Furthermore, A promising avenue for future research involves integrating longitudinal studies to establish and verify causal relationships identified within the sustainability functions with greater confidence. By employing longitudinal research designs, researchers can examine the temporal dynamics and changes in the sustainability functions over the course of Industry 5.0 evolution. This approach would enable a deeper understanding of how these relationships evolve and whether they maintain their significance and strength over time. Furthermore, exploring the long-term effects and dynamics of identified causal relationships through longitudinal studies would contribute to a more comprehensive understanding of how digital industrial transformation should adhere to inclusive sustainability.

Finally and yet importantly, the sustainability functions identified within the present study may not have the inclusiveness to address all the sustainability concerns of the Industry 5.0 agenda. Indeed, some of the sustainability concerns highlighted within the Industry 5.0 agenda have nothing to do with the mismanagement of Industry 4.0. Conditions such as redefining the role of corporate responsibility, bypassing neo-liberal capitalism toward shareholder supremacy, or synchronising the public sector with the pace of change appear to be the enablers of Industry 5.0 sustainability values that fall outside the Industry 4.0 context. Therefore, we encourage future research to build on the present study as a stepping stone and integrate the sustainability functions of Industry 4.0 with other socio-political requirements to develop more comprehensive strategy roadmaps that inclusively empower all sustainability priorities of Industry 5.0.

## Appendix: Self-Assessment Questionnaire

1. How familiar are you with the Industry 4.0 And 5.0 frameworks proposed by the European Commission?
2. How familiar are you with the scientific and industrial background of Industry 5.0?
3. How familiar are you with the mechanisms through which Industry 4.0 can promote sustainable development?
4. Please briefly explain your past collaboration with the European Commission that might somehow relate to Industry 5.0-driven sustainability. Examples may include collaboration as a principal investigator, senior researcher, or advisory board member on related topics such as technology governance, digital transformation, Industry 4.0, sustainability, digitally-driven circular economy, or resilient economy.
5. How likely would it be for you to commit to identifying the pair-wise relationships among all the functions? Kindly note that filling out the questionnaire will take up to 60 min.
6. How would you rate your English proficiency in understanding the technical terms in the context of the study and engaging in filling out the questionnaire?

**Acknowledgements** This research has been a part of a project that received funding from the European Union's Horizon 2020 research and innovation programme under grant agreement No 810318.

**Authors' Contributions** *Morteza Ghobakhloo*: Conceptualization, Methodology, Data Curation, Visualization, Writing - Original Draft, Writing - Review & Editing, Project administration, Funding acquisition.

*Hannan Amoozad Mahdiraji*: Visualization, Methodology, Writing - Original Draft, Writing, Writing - Review & Editing, Formal analysis.

*Mohammad Iranmanesh*: Data Curation, Conceptualization, Formal analysis, Writing - Original Draft, Writing - Review & Editing, Methodology, Validation. *Vahid Jafari-Sadeghi*: Conceptualization, Methodology, Writing - Original Draft, Writing - Review & Editing, Project administration.

**Funding** Open access funding provided by Uppsala University. Horizon 2020 research and innovation programme (No 810318).

**Data availability** The data will be available upon request.

## Declarations

**Ethics Approval and Consent to Participate** Not applicable.

**Consent for Publication** Not applicable.

**Competing Interests** There is no conflict of interest.

**Open Access** This article is licensed under a Creative Commons Attribution 4.0 International License, which permits use, sharing, adaptation, distribution and reproduction in any medium or format, as long as you give appropriate credit to the original author(s) and the source, provide a link to the Creative Commons licence, and indicate if changes were made. The images or other third party material in this article are included in the article's Creative Commons licence, unless indicated

otherwise in a credit line to the material. If material is not included in the article's Creative Commons licence and your intended use is not permitted by statutory regulation or exceeds the permitted use, you will need to obtain permission directly from the copyright holder. To view a copy of this licence, visit <http://creativecommons.org/licenses/by/4.0/>.

## References

- Abdul-Hamid, A. Q., Ali, M. H., Tseng, M. L., Lan, S., & Kumar, M. (2020). Impeding challenges on industry 4.0 in circular economy: Palm oil industry in Malaysia. *Computers and Operations Research*, *123*, 105052. <https://doi.org/10.1016/j.cor.2020.105052>
- Adamik, A., & Sikora-Fernandez, D. (2021). Smart organizations as a source of competitiveness and sustainable development in the age of industry 4.0: Integration of micro and macro perspective. *Energies*, *14*(6), 1572. <https://doi.org/10.3390/en14061572>
- Agarwal, V., Mathiyazhagan, K., Malhotra, S., & Saikouk, T. (2021). Analysis of challenges in sustainable human resource management due to disruptions by industry 4.0: An emerging economy perspective. *International Journal of Manpower*. <https://doi.org/10.1108/IJM-03-2021-0192>
- Ahmed, S., Irshad, L., & Demirel, H. O. (2021). Prototyping human-centered products in the age of industry 4.0. *Journal of Mechanical Design Transactions of the ASME*, *143*(7). <https://doi.org/10.1115/1.4050736>
- Al Amiri, N., & Shawali, A. A. (2021). Talent management strategies of a public UAE hospital in the industry 4.0 ERA: A qualitative analysis. *Problems and Perspectives in Management*, *19*(2), 14–27. [https://doi.org/10.21511/ppm.19\(2\).2021.02](https://doi.org/10.21511/ppm.19(2).2021.02)
- Amjad, M. S., Rafique, M. Z., & Khan, M. A. (2021). Modern divulge in production optimization: An implementation framework of LARG manufacturing with industry 4.0. *International Journal of Lean Six Sigma*, *12*(5), 992–1016. <https://doi.org/10.1108/IJLSS-07-2020-0099>
- Amoozad Mahdiraji, H., Yaftiyan, F., Abbasi Kamardi, A. A., Garza-Reyes, J. A., & Razavi Hajiagha, S. H. (2023). The role of industry 4.0 technologies on performance measurement systems of supply chains during global pandemics: An interval-valued intuitionistic hesitant fuzzy approach. *International Journal of Quality & Reliability Management*, *40*(5), 1147–1171. <https://doi.org/10.1108/IJQRM-03-2022-0094>
- Ante, L. (2021). Digital twin technology for smart manufacturing and industry 4.0: A bibliometric analysis of the intellectual structure of the research discourse. *Manufacturing Letters*, *27*, 96–102. <https://doi.org/10.1016/j.mfglet.2021.01.003>
- Aslam, H., Blome, C., Roscoe, S., & Azhar, T. M. (2018). Dynamic supply chain capabilities. *International Journal of Operations & Production Management*, *38*(12), 2266–2285. <https://doi.org/10.1108/IJOPM-09-2017-0555>
- Atanassov, K. T. (1986). Intuitionistic fuzzy sets. *Fuzzy Sets and Systems*, *20*(1), 87–96.
- Ayinde, L., & Kirkwood, H. (2020). Rethinking the roles and skills of information professionals in the 4th Industrial Revolution. *Business Information Review*, *37*(4), 142–153. <https://doi.org/10.1177/0266382120968057>
- Badri, A., Boudreau-Trudel, B., & Souissi, A. S. (2018). Occupational health and safety in the industry 4.0 era: A cause for major concern? *Safety Science*, *109*, 403–411. <https://doi.org/10.1016/j.ssci.2018.06.012>
- Bag, S., Gupta, S., & Kumar, S. (2021a). Industry 4.0 adoption and 10R advance manufacturing capabilities for sustainable development. *International Journal of Production Economics*, *231*. <https://doi.org/10.1016/j.ijpe.2020.107844>

- Bag, S., Wood, L. C., Telukdarie, A., & Venkatesh, V. G. (2021b). Application of industry 4.0 tools to empower circular economy and achieving sustainability in supply chain operations. *Production Planning and Control*, 1–23. <https://doi.org/10.1080/09537287.2021.1980902>
- Bai, C., Orzes, G., & Sarkis, J. (2022). Exploring the impact of industry 4.0 technologies on social sustainability through a circular economy approach. *Industrial Marketing Management*, 101, 176–190. <https://doi.org/10.1016/j.indmarman.2021.12.004>
- Barzotto, M., Corradini, C., Fai, F., Labory, S., & Tomlinson, P. R. (2020). Smart specialisation, industry 4.0 and lagging regions: Some directions for policy. *Regional Studies Regional Science*, 7(1), 318–332. <https://doi.org/10.1080/21681376.2020.1803124>
- Bazan, P., & Estevez, E. (2022). Industry 4.0 and business process management: State of the art and new challenges. *Business Process Management Journal*, 28(1), 62–80. <https://doi.org/10.1108/BPMJ-04-2020-0163>
- Bécue, A., Praça, I., & Gama, J. (2021). Artificial intelligence, cyber-threats and industry 4.0: Challenges and opportunities. *Artificial Intelligence Review*, 54(5), 3849–3886. <https://doi.org/10.1007/s10462-020-09942-2>
- Bhattacharyya, S., & Mitra, A. (2020). Fourth industrial revolution and India's employment problem. *International Journal of Social Economics*, 47(7), 851–866. <https://doi.org/10.1108/IJSE-09-2019-0540>
- Bi, Z. M., Chen, B., Xu, L., Wu, C., Malott, C., Chamberlin, M., & Enterline, T. (2021). Security and safety assurance of collaborative manufacturing in industry 4.0. *Enterprise Information Systems*. <https://doi.org/10.1080/17517575.2021.2008512>
- Bigerna, S., D'Errico, M. C., & Polinori, P. (2021a). Energy security and RES penetration in a growing decarbonized economy in the era of the 4th industrial revolution. *Technological Forecasting and Social Change*, 166. <https://doi.org/10.1016/j.techfore.2021.120648>
- Bigerna, S., Micheli, S., & Polinori, P. (2021b). New generation acceptability towards durability and reparability of products: Circular economy in the era of the 4th industrial revolution. *Technological Forecasting and Social Change*, 165. <https://doi.org/10.1016/j.techfore.2020.120558>
- Birkel, H., & Müller, J. M. (2021). Potentials of industry 4.0 for supply chain management within the triple bottom line of sustainability – a systematic literature review. *Journal of Cleaner Production*, 289, 125612. <https://doi.org/10.1016/j.jclepro.2020.125612>
- Breque, M., Nul, L. D., & Petridis, A. (2021). Industry 5.0: Towards a sustainable, humancentric and resilient European industry. *European Commission, Directorate-General for Research and Innovation*. <https://data.europa.eu/doi/10.2777/308407>. Accessed Nov 2021.
- Cañas, H., Mula, J., Díaz-Madroño, M., & Campuzano-Bolarín, F. (2021). Implementing industry 4.0 principles. *Computers & Industrial Engineering*, 158, 107379. <https://doi.org/10.1016/j.cie.2021.107379>
- Chen, M., Sinha, A., Hu, K., & Shah, M. I. (2021). Impact of technological innovation on energy efficiency in industry 4.0 era: Moderation of shadow economy in sustainable development. *Technological Forecasting and Social Change*, 164, 120521. <https://doi.org/10.1016/j.techfore.2020.120521>
- Cheng, Y., Awan, U., Ahmad, S., & Tan, Z. (2021). How do technological innovation and fiscal decentralization affect the environment? A story of the fourth industrial revolution and sustainable growth. *Technological Forecasting and Social Change*, 162, 120398. <https://doi.org/10.1016/j.techfore.2020.120398>
- Chiarini, A. (2021). Industry 4.0 technologies in the manufacturing sector: Are we sure they are all relevant for environmental performance? *Business Strategy and the Environment*, 30(7), 3194–3207.
- Chiarini, A., Belvedere, V., & Grando, A. (2020). Industry 4.0 strategies and technological developments. An exploratory research from Italian manufacturing companies. *Production Planning and Control*, 31(16), 1385–1398. <https://doi.org/10.1080/09537287.2019.1710304>
- Chiengkul, P. (2019). Uneven development, inequality and concentration of power: A critique of Thailand 4.0. *Third World Quarterly*, 40(9), 1689–1707.
- Ching, N. T., Ghobakhloo, M., Iranmanesh, M., Maroufkhani, P., & Asadi, S. (2022). Industry 4.0 applications for sustainable manufacturing: A systematic literature review and a roadmap to sustainable development. *Journal of Cleaner Production*, 334, 130133. <https://doi.org/10.1016/j.jclepro.2021.130133>
- Ciffolilli, A., & Muscio, A. (2018). Industry 4.0: National and regional comparative advantages in key enabling technologies. *European Planning Studies*, 26(12), 2323–2343. <https://doi.org/10.1080/09654313.2018.1529145>
- Dalenogare, L. S., Benitez, G. B., Ayala, N. F., & Frank, A. G. (2018). The expected contribution of industry 4.0 technologies for industrial performance. *International Journal of Production Economics*, 204, 383–394.
- de Assis Dornelles, J., Ayala, N. F., & Frank, A. G. (2022). Smart Working in Industry 4.0: How digital technologies enhance manufacturing workers' activities. *Computers & Industrial Engineering*, 163, 107804.
- Dev, N. K., Shankar, R., & Swami, S. (2020). Diffusion of green products in industry 4.0: Reverse logistics issues during design of inventory and production planning system. *International Journal of Production Economics*, 223, 107519. <https://doi.org/10.1016/j.ijpe.2019.107519>
- Dhir, S., & Dhir, S. (2020). Modeling of strategic thinking enablers: A modified total interpretive structural modeling (TISM) and MICMAC approach. *International Journal of System Assurance Engineering and Management*, 11(1), 175–188.
- Dixit, A., Jakhar, S. K., & Kumar, P. (2022). Does lean and sustainable manufacturing lead to industry 4.0 adoption: The mediating role of ambidextrous innovation capabilities. *Technological Forecasting and Social Change*, 175, 121328.
- Dolatabad, A. H., Mahdiraji, H. A., Babgohari, A. Z., Garza-Reyes, J. A., & Ai, A. (2022). Analyzing the key performance indicators of circular supply chains by hybrid fuzzy cognitive mapping and fuzzy DEMATEL: Evidence from healthcare sector. *Environmental Development and Sustainability*. <https://doi.org/10.1007/s10668-022-02535-9>
- Dolgui, A., & Ivanov, D. (2020). *Exploring supply chain structural dynamics: New disruptive technologies and disruption risks* (Vol. 229, pp. 107886). Elsevier.
- Doyle Kent, M., & Kopacek, P. (2021). Do We Need Synchronization of the Human and Robotics to Make Industry 5.0 a Success Story? In *International Symposium for Production Research, ISPR 2020* (pp. 302–311). Springer Science and Business Media Deutschland GmbH.
- Durand, C., & Milberg, W. (2020). Intellectual monopoly in global value chains. *Review of International Political Economy*, 27(2), 404–429.
- Enyoghasi, C., & Badurdeen, F. (2021). Industry 4.0 for sustainable manufacturing: Opportunities at the product, process, and system levels. *Resources, Conservation and Recycling*, 166, 105362. <https://doi.org/10.1016/j.resconrec.2020.105362>
- Ertz, M., Sun, S., Boily, E., Kubiak, P., & Quenum, G. G. Y. (2022). How transitioning to industry 4.0 promotes circular product lifetimes. *Industrial Marketing Management*, 101, 125–140.
- Eslami, M. H., Jafari, H., Achtenhagen, L., Carlback, J., & Wong, A. (2021). Financial performance and supply chain dynamic capabilities: The moderating role of industry 4.0 technologies. *International Journal of Production Research*, 1–18. <https://doi.org/10.1080/00207543.2021.1966850>
- Fareri, S., Fantoni, G., Chiarello, F., Coli, E., & Binda, A. (2020). Estimating industry 4.0 impact on job profiles and skills using text mining. *Computers in Industry*, 118, 103222. <https://doi.org/10.1016/j.compind.2020.103222>

- Fathi, M., & Ghobakhloo, M. (2020). Enabling mass customization and manufacturing sustainability in Industry 4.0 Context: A novel heuristic algorithm for in-plant material supply optimization. *Sustainability (Switzerland)*, 12(16). <https://doi.org/10.3390/su12166669>
- Fatorachian, H., & Kazemi, H. (2021). Impact of industry 4.0 on supply chain performance. *Production Planning & Control*, 32(1), 63–81.
- Fernando, Y., Jabbour, C. J. C., & Wah, W. X. (2019). Pursuing green growth in technology firms through the connections between environmental innovation and sustainable business performance: Does service capability matter? *Resources, Conservation and Recycling*, 141, 8–20.
- Frank, A. G., Dalenogare, L. S., & Ayala, N. F. (2019a). Industry 4.0 technologies: Implementation patterns in manufacturing companies. *International Journal of Production Economics*, 210, 15–26.
- Frank, A. G., Mendes, G. H., Ayala, N. F., & Ghezzi, A. (2019b). Servitization and industry 4.0 convergence in the digital transformation of product firms: A business model innovation perspective. *Technological Forecasting and Social Change*, 141, 341–351.
- Gebhardt, M., Kopyto, M., Birkel, H., & Hartmann, E. (2021). Industry 4.0 technologies as enablers of collaboration in circular supply chains: A systematic literature review. *International Journal of Production Research*, 1–29. <https://doi.org/10.1080/00207543.2021.1999521>
- Ghadge, A., Er Kara, M., Moradlou, H., & Goswami, M. (2020). The impact of industry 4.0 implementation on supply chains. *Journal of Manufacturing Technology Management*, 31(4), 669–686. <https://doi.org/10.1108/JMTM-10-2019-0368>
- Ghobakhloo, M. (2020). Industry 4.0, digitization, and opportunities for sustainability. *Journal of Cleaner Production*, 252, 119869. <https://doi.org/10.1016/j.jclepro.2019.119869>
- Ghobakhloo, M., & Fathi, M. (2020). Corporate survival in industry 4.0 era: The enabling role of lean-digitized manufacturing. *Journal of Manufacturing Technology Management*, 31(1), 1–30. <https://doi.org/10.1108/JMTM-11-2018-0417>
- Ghobakhloo, M., & Fathi, M. (2021). Industry 4.0 and opportunities for energy sustainability. *Journal of Cleaner Production*, 295, 126427. <https://doi.org/10.1016/j.jclepro.2021.126427>
- Ghobakhloo, M., Iranmanesh, M., Grybauskas, A., Vilkas, M., & Petraitė, M. (2021a). Industry 4.0, innovation, and sustainable development: A systematic review and a roadmap to sustainable innovation. *Business Strategy and the Environment*, 30(8), 4237–4257. <https://doi.org/10.1002/bse.2867>
- Ghobakhloo, M., Fathi, M., Iranmanesh, M., Maroufkhani, P., & Morales, M. E. (2021b). Industry 4.0 ten years on: A bibliometric and systematic review of concepts, sustainability value drivers, and success determinants. *Journal of Cleaner Production*, 302, 127052.
- Ghobakhloo, M., Iranmanesh, M., Mubarak, M. F., Mubarik, M., Rejeb, A., & Nilashi, M. (2022). Identifying industry 5.0 contributions to sustainable development: A strategy roadmap for delivering sustainability values. *Sustainable Production and Consumption*, 33, 716–737.
- Ghobakhloo, M., Iranmanesh, M., Morales, M. E., Nilashi, M., & Amran, A. (2023a). Actions and approaches for enabling industry 5.0-driven sustainable industrial transformation: A strategy roadmap. *Corporate Social Responsibility and Environmental Management*, 30(3), 1473–1494. <https://doi.org/10.1002/csr.2431>
- Ghobakhloo, M., Iranmanesh, M., Tseng, M. L., Grybauskas, A., Stefanini, A., & Amran, A. (2023b). Behind the definition of industry 5.0: A systematic review of technologies, principles, components, and values. *Journal of Industrial and Production Engineering*, 40(6), 432–447. <https://doi.org/10.1080/21681015.2023.2216701>
- Greef, S., & Schroeder, W. (2021). How does industry 4.0 affect the relationship between centre and periphery? The case of manufacturing industry in Germany. *European Planning Studies*, 29(9), 1656–1671.
- Grybauskas, A., Stefanini, A., & Ghobakhloo, M. (2022). Social sustainability in the age of digitalization: A systematic literature review on the social implications of industry 4.0. *Technology in Society*, 70, 101997.
- Gupta, S., Modgil, S., Gunasekaran, A., & Bag, S. (2020). Dynamic capabilities and institutional theories for Industry 4.0 and digital supply chain. *Supply Chain Forum: An International Journal*, 21(3), 139–157. <https://doi.org/10.1080/16258312.2020.1757369>
- Hahn, G. J. (2020). Industry 4.0: A supply chain innovation perspective. *International Journal of Production Research*, 58(5), 1425–1441. <https://doi.org/10.1080/00207543.2019.1641642>
- Haiss, P., Mahlberg, B., & Michlits, D. (2021). Industry 4.0—the future of Austrian jobs. *Empirica*, 48(1), 5–36. <https://doi.org/10.1007/s10663-020-09497-z>
- Hashemi, S. S., Mahdiraji, A., Azari, H., M., & Razavi Hajiagha, S. H. (2022). Causal modelling of failure fears for international entrepreneurs in tourism industry: A hybrid Delphi-DEMATEL based approach. *International Journal of Entrepreneurial Behavior & Research*, 28(3), 602–627. <https://doi.org/10.1108/IJEBR-03-2021-0193>
- Hayriye, A., & Fatma, Ü. (2020). Industry 4.0-related digital divide in enterprises: An analysis for the European union-28. *Sosyoloji*, 28(45), 225–244.
- Hein-Pensel, F., Winkler, H., Brückner, A., Wölke, M., Jabs, I., Mayan, I. J., Kirschenbaum, A., Friedrich, J., & Zinke-Wehlmann, C. (2023). Maturity assessment for industry 5.0: A review of existing maturity models. *Journal of Manufacturing Systems*, 66, 200–210. <https://doi.org/10.1016/j.jmsy.2022.12.009>
- Henemann Hilario da Silva, T., & Sehnem, S. (2022). The circular economy and Industry 4.0: synergies and challenges. *Revista de Gestão*, 29(3), 300–313. <https://doi.org/10.1108/REGE-07-2021-0121>
- Hilpert, U. (2021). Regional selectivity of innovative progress: Industry 4.0 and digitization ahead. *European Planning Studies*, 29(9), 1589–1605. <https://doi.org/10.1080/09654313.2021.1963047>
- Huang, S., Wang, B., Li, X., Zheng, P., Mourtzis, D., & Wang, L. (2022). Industry 5.0 and Society 5.0—Comparison, complementation and co-evolution. *Journal of Manufacturing Systems*, 64, 424–428. <https://doi.org/10.1016/j.jmsy.2022.07.010>
- Iqbal, M., Ma, J., Ahmad, N., Hussain, K., & Usmani, M. (2021). Promoting sustainable construction through energy-efficient technologies: An analysis of promotional strategies using interpretive structural modeling. *International Journal of Environmental Science and Technology*, 18(11), 3479–3502.
- Iqbal, M., Ma, J., Ahmad, N., Ullah, Z., & Hassan, A. (2023). Energy-efficient supply chains in construction industry: An analysis of critical success factors using ISM-MICMAC approach. *International Journal of Green Energy*, 20(3), 265–283. <https://doi.org/10.1080/15435075.2022.2038609>
- Ivanov, D. (2020). Viable supply chain model: Integrating agility, resilience and sustainability perspectives—lessons from and thinking beyond the COVID-19 pandemic. *Annals of Operations Research*. <https://doi.org/10.1007/s10479-020-03640-6>
- Ivanov, D. (2022). The industry 5.0 framework: Viability-based integration of the resilience, sustainability, and human-centricity perspectives. *International Journal of Production Research*, 1–13. <https://doi.org/10.1080/00207543.2022.2118892>
- Ivanov, D. (2023). The Industry 5.0 framework: Viability-based integration of the resilience, sustainability, and human-centricity perspectives. *International Journal of Production Research*, 61(5), 1683–1695. <https://doi.org/10.1080/00207543.2022.2118892>
- Ivanov, D., & Dolgui, A. (2021). A digital supply chain twin for managing the disruption risks and resilience in the era of industry 4.0. *Production Planning and Control*, 32(9), 775–788. <https://doi.org/10.1080/09537287.2020.1768450>

- Ivanov, D., Dolgui, A., & Sokolov, B. (2019). The impact of digital technology and industry 4.0 on the ripple effect and supply chain risk analytics. *International Journal of Production Research*, 57(3), 829–846. <https://doi.org/10.1080/00207543.2018.1488086>
- Ivanov, D., Dolgui, A., & Sokolov, B. (2022). Cloud supply chain: Integrating industry 4.0 and digital platforms in the supply chain-as-a-Service. *Transportation Research Part E: Logistics and Transportation Review*, 160, 102676.
- Jafari-Sadeghi, V., Mahdiraji, H. A., Bresciani, S., & Pellicelli, A. C. (2021). Context-specific micro-foundations and successful SME internationalisation in emerging markets: A mixed-method analysis of managerial resources and dynamic capabilities. *Journal of Business Research*, 134, 352–364.
- Jamaludin, R., McKay, E., & Ledger, S. (2020). Are we ready for Education 4.0 within ASEAN higher education institutions? Thriving for knowledge, industry and humanity in a dynamic higher education ecosystem? *Journal of Applied Research in Higher Education*, 12(5), 1161–1173. <https://doi.org/10.1108/JARHE-06-2019-0144>
- Jr, N. K., Silva, J. F. d., Ghobakhloo, M., Ritter, A. M., Silva, D. O. d., & Sellitto, M. A. (2022). Industry 4.0 technologies and sustainability challenges: A case study in the coal mining industry. *International Journal of Product Lifecycle Management*, 14(2-3), 186–205. <https://doi.org/10.1504/IJPLM.2022.125818>
- Kache, F., & Seuring, S. (2017). Challenges and opportunities of digital information at the intersection of Big Data Analytics and supply chain management. *International Journal of Operations & Production Management*, 37(1), 10–36. <https://doi.org/10.1108/IJOPM-02-2015-0078>
- Kanojia, A., & Visvanathan, C. (2021). Assessment of urban solid waste management systems for industry 4.0 technology interventions and the circular economy. *Waste Management and Research*, 39(11), 1414–1426. <https://doi.org/10.1177/0734242X21992424>
- Karmaker, C. L., Bari, A. M., Anam, M. Z., Ahmed, T., Ali, S. M., de Jesus Pacheco, D. A., & Maktadir, M. A. (2023). Industry 5.0 challenges for post-pandemic supply chain sustainability in an emerging economy. *International Journal of Production Economics*, 258, 108806.
- Karre, H., Hammer, M., Kleindienst, M., & Ramsauer, C. (2017). Transition towards an industry 4.0 state of the LeanLab at Graz University of Technology. *Procedia Manufacturing*, 9, 206–213.
- Kazancoglu, I., Ozbiltekin-Pala, M., Kumar Mangla, S., Kazancoglu, Y., & Jabeen, F. (2022). Role of flexibility, agility and responsiveness for sustainable supply chain resilience during COVID-19. *Journal of Cleaner Production*, 362, 132431. <https://doi.org/10.1016/j.jclepro.2022.132431>
- Kazancoglu, Y., Sezer, M. D., Ozkan-Ozen, Y. D., Mangla, S. K., & Kumar, A. (2021). Industry 4.0 impacts on responsible environmental and societal management in the family business. *Technological Forecasting and Social Change*, 173, 121108. <https://doi.org/10.1016/j.techfore.2021.121108>
- Kerin, M., & Pham, D. T. (2019). A review of emerging industry 4.0 technologies in remanufacturing. *Journal of Cleaner Production*, 237, 117805.
- Khaba, S., Bhar, C., & Ray, A. (2021). A study on key lean enablers of the coal mining sector using ISM, MICMAC and SEM. *The TQM Journal*, 33(6), 1281–1305. <https://doi.org/10.1108/TQM-04-2020-0069>
- Kiel, D., Müller, J. M., Arnold, C., & Voigt, K. I. (2017). Sustainable industrial value creation: Benefits and challenges of industry 4.0. *International Journal of Innovation Management*, 21(8). <https://doi.org/10.1142/S1363919617400151>
- Kondo, K., Noonan, K. M., Freeman, M., Ayers, C., Morasco, B. J., & Kansagara, D. (2019). Efficacy of biofeedback for medical conditions: An evidence map. *Journal of General Internal Medicine*, 34(12), 2883–2893.
- Kovacs, O. (2018). The dark corners of industry 4.0 – grounding economic governance 2.0. *Technology in Society*, 55, 140–145. <https://doi.org/10.1016/j.techsoc.2018.07.009>
- Leng, J., Ruan, G., Jiang, P., Xu, K., Liu, Q., Zhou, X., & Liu, C. (2020). Blockchain-empowered sustainable manufacturing and product lifecycle management in industry 4.0: A survey. *Renewable and Sustainable Energy Reviews*, 132, 110112. <https://doi.org/10.1016/j.rser.2020.110112>
- Libai, B., Bart, Y., Gensler, S., Hofacker, C. F., Kaplan, A., Kötterheirich, K., & Kroll, E. B. (2020). Brave new world? On AI and the management of customer relationships. *Journal of Interactive Marketing*, 51, 44–56.
- Lim, C. H., Loh, Y. W., Foo, D. C. Y., Ng, W. P. Q., & Lam, H. L. (2021). Circular economy and industry 4.0 technology integration framework for the oil palm industry. *Chemical Engineering Transactions*, 88. <https://doi.org/10.3303/CET2188211>
- Liu, B., & De Giovanni, P. (2019). Green process innovation through industry 4.0 technologies and supply chain coordination. *Annals of Operations Research*. <https://doi.org/10.1007/s10479-019-03498-3>
- Longo, F., Nicoletti, L., & Padovano, A. (2017). Smart operators in industry 4.0: A human-centered approach to enhance operators' capabilities and competencies within the new smart factory context. *Computers and Industrial Engineering*, 113, 144–159. <https://doi.org/10.1016/j.cie.2017.09.016>
- Longo, F., Nicoletti, L., & Padovano, A. (2022). New perspectives and results for Smart operators in industry 4.0: A human-centered approach. *Computers and Industrial Engineering*, 163, 107824. <https://doi.org/10.1016/j.cie.2021.107824>
- Longo, F., Padovano, A., & Umbrello, S. (2020). Value-oriented and ethical technology engineering in industry 5.0: A human-centric perspective for the design of the factory of the future. *Applied Sciences (Switzerland)*, 10(12), 1–25. <https://doi.org/10.3390/AP10124182>
- Lopes, S., Jabbour, A. B., Frascarelli, F. C. D. O., Gonzalez, S., E. D. R., & Chiappetta Jabbour, C. J. (2021). Are food supply chains taking advantage of the circular economy? A research agenda on tackling food waste based on industry 4.0 technologies. *Production Planning and Control*. <https://doi.org/10.1080/09537287.2021.1980903>
- Luthra, S., & Mangla, S. K. (2018). Evaluating challenges to industry 4.0 initiatives for supply chain sustainability in emerging economies. *Process Safety and Environmental Protection*, 117, 168–179. <https://doi.org/10.1016/j.psep.2018.04.018>
- Maddikunta, P. K. R., Pham, Q. V., Prabadevi, B., Deepa, N., Dev, K., Gadekallu, T. R., Ruby, R., & Liyanage, M. (2022). Industry 5.0: A survey on enabling technologies and potential applications. *Journal of Industrial Information Integration*, 26, 100257.
- Mahdiraji, H. A., Sedigh, M., Hajiaghaz, S. H. R., Garza-Reyes, J. A., Jafari-Sadeghi, V., & Dana, L. P. (2021). A novel time, cost, quality and risk tradeoff model with a knowledge-based hesitant fuzzy information: An R&D project application. *Technological Forecasting and Social Change*, 172, 121068.
- Malik, A., Ul Haq, M. I., Raina, A., & Gupta, K. (2022). 3D printing towards implementing industry 4.0: Sustainability aspects, barriers and challenges. *Industrial Robot*. <https://doi.org/10.1108/IR-10-2021-0247>
- Margherita, E. G., & Braccini, A. M. (2020). Industry 4.0 technologies in Flexible Manufacturing for sustainable Organizational Value: Reflections from a multiple case study of Italian manufacturers. *Information Systems Frontiers*. <https://doi.org/10.1007/s10796-020-10047-y>
- Margherita, E. G., & Braccini, A. M. (2021). Managing industry 4.0 automation for fair ethical business development: A single

- case study. *Technological Forecasting and Social Change*, 172, 121048.
- Markard, J. (2020). The life cycle of technological innovation systems. *Technological Forecasting and Social Change*, 153, 119407. <https://doi.org/10.1016/j.techfore.2018.07.045>
- Mastos, T. D., Nizamis, A., Terzi, S., Gkortzis, D., Papadopoulos, A., Tsagkalidis, N., & Tzovaras, D. (2021). Introducing an application of an industry 4.0 solution for circular supply chain management. *Journal of Cleaner Production*, 300, 126886. <https://doi.org/10.1016/j.jclepro.2021.126886>
- Mefi, N. P., & Asoba, S. N. (2020). Industry 4.0 and skills deficiencies in the Hrm function: Case Study of the Hrm Department of a selected organisation in Cape Town. *Academy of Entrepreneurship Journal*, 27(2), 1–9. Retrieved from <https://www.scopus.com/inward/record.uri?eid=2-s2.0-85106662833&partnerID=40&md5=753a9868df53cac5cf71350725b45cdf>. Accessed Apr 2022.
- Melé, D. (2021). Ethics at the workplace in the fourth industrial revolution: A catholic social teaching perspective. *Business Ethics Environment and Responsibility*, 30(4), 772–783. <https://doi.org/10.1111/beer.12368>
- Min, J., Kim, Y., Lee, S., Jang, T. W., Kim, I., & Song, J. (2019). The Fourth Industrial Revolution and its impact on Occupational Health and Safety, Worker's compensation and labor conditions. *Safety and Health at Work*, 10(4), 400–408. <https://doi.org/10.1016/j.shaw.2019.09.005>
- Mishra, D., Roy, R. B., Dutta, S., Pal, S. K., & Chakravarty, D. (2018). A review on sensor based monitoring and control of friction stir welding process and a roadmap to industry 4.0. *Journal of Manufacturing Processes*, 36, 373–397. <https://doi.org/10.1016/j.jmapro.2018.10.016>
- Mönnig, A., Maier, T., & Zika, G. (2019). Economy 4.0—digitalisation and its effect on wage inequality. *Jahrbücher Für Nationalökonomie Und Statistik*, 239(3), 363–398.
- Mubarak, M. F., Tiwari, S., Petraite, M., Mubarik, M., & Rasi, R. M. (2021). How industry 4.0 technologies and open innovation can improve green innovation performance? *Management of Environmental Quality: An International Journal*, 32(5), 1007–1022. <https://doi.org/10.1108/MEQ-11-2020-0266>
- Mubarik, M. S., Naghavi, N., Mubarik, M., Kusi-Sarpong, S., Khan, S. A., Zaman, S. I., & Kazmi, S. H. A. (2021). Resilience and cleaner production in industry 4.0: Role of supply chain mapping and visibility. *Journal of Cleaner Production*, 292, 126058. <https://doi.org/10.1016/j.jclepro.2021.126058>
- Mukherjee, A. A., Raj, A., & Aggarwal, S. (2023). Identification of barriers and their mitigation strategies for industry 5.0 implementation in emerging economies. *International Journal of Production Economics*, 257, 108770. <https://doi.org/10.1016/j.ijpe.2023.108770>
- Müller, J. M. (2019). Assessing the barriers to industry 4.0 implementation from a workers' perspective. *IFAC-PapersOnLine*, 52(13), 2189–2194. <https://doi.org/10.1016/j.ifacol.2019.11.530>
- Müller, J. (2020). Enabling Technologies for Industry 5.0: results of a workshop with Europe's technology leaders. <https://doi.org/10.2777/082634>
- Mushtaq, F., Bland, A. R., & Schaefer, A. (2011). Uncertainty and cognitive control. *Frontiers in Psychology*, 2, 249.
- Nahavandi, S. (2019). Industry 5.0—a human-centric solution. *Sustainability (Switzerland)*, 11(16). <https://doi.org/10.3390/su11164371>
- Nara, E. O. B., da Costa, M. B., Baierle, I. C., Schaefer, J. L., Benitez, G. B., do Santos, L. M. A. L., & Benitez, L. B. (2021). Expected impact of industry 4.0 technologies on sustainable development: A study in the context of Brazil's plastic industry. *Sustainable Production and Consumption*, 25, 102–122.
- O'Donovan, P., Gallagher, C., Leahy, K., & O'Sullivan, D. T. J. (2019). A comparison of fog and cloud computing cyber-physical interfaces for industry 4.0 real-time embedded machine learning engineering applications. *Computers in Industry*, 110, 12–35. <https://doi.org/10.1016/j.compind.2019.04.016>
- Oláh, J., Aburumman, N., Popp, J., Khan, M. A., Haddad, H., & Kitukutha, N. (2020). Impact of industry 4.0 on environmental sustainability. *Sustainability (Switzerland)*, 12(11). <https://doi.org/10.3390/su12114674>
- Ooi, K. B., Tan, G. W. H., Al-Emran, M., Al-Sharafi, M. A., Capatina, A., Chakraborty, A., Dwivedi, Y. K., Huang, T. L., Kar, A. K., Lee, V. H., Loh, X. M., Micu, A., Mikalef, P., Mogaji, E., Pandey, N., Raman, R., Rana, N. P., Sarker, P., Sharma, A., & Wong, L. W. (2023). The potential of generative artificial intelligence across disciplines: Perspectives and future directions. *Journal of Computer Information Systems*, 1–32, 1. <https://doi.org/10.1080/08874417.2023.2261010>
- Özdemir, V., & Hekim, N. (2018). Birth of industry 5.0: Making sense of big data with artificial intelligence, the internet of things and next-generation technology policy. *OMICSA Journal of Integrative Biology*, 22(1), 65–76. <https://doi.org/10.1089/omi.2017.0194>
- Pacaux-Lemoine, M. P., Trentesaux, D., Rey, G. Z., & Millot, P. (2017). Designing intelligent manufacturing systems through human-machine cooperation principles: A human-centered approach. *Computers & Industrial Engineering*, 111, 581–595.
- Pandey, S., Singh, R. K., & Gunasekaran, A. (2021). Supply chain risks in industry 4.0 environment: Review and analysis framework. *Production Planning and Control*. <https://doi.org/10.1080/09537287.2021.2005173>
- Pardi, T. (2019). Fourth industrial revolution concepts in the automotive sector: Performativity, work and employment. *Journal of Industrial and Business Economics*, 46(3), 379–389. <https://doi.org/10.1007/s40812-019-00119-9>
- Psarommatis, F., Sousa, J., Mendonça, J. P., & Kiritsis, D. (2021). Zero-defect manufacturing the approach for higher manufacturing sustainability in the era of industry 4.0: A position paper. *International Journal of Production Research*. <https://doi.org/10.1080/00207543.2021.1987551>
- Rainnie, A., & Dean, M. (2020). Industry 4.0 and the future of quality work in the global digital economy. *Labour & Industry: A Journal of the Social and Economic Relations of work*, 30(1), 16–33.
- Rajput, S., & Singh, S. P. (2020). Industry 4.0 model for circular economy and cleaner production. *Journal of Cleaner Production*, 277, 123853. <https://doi.org/10.1016/j.jclepro.2020.123853>
- Rana, G., & Sharma, R. (2019). Emerging human resource management practices in industry 4.0. *Strategic HR Review*, 18(4), 176–181. <https://doi.org/10.1108/SHR-01-2019-0003>
- Razavi Hajiagha, S. H., Ahmadzadeh Kandi, N., Mahdiraji, A., Jafari-Sadeghi, H., & Hashemi, S. S. (2022a). International entrepreneurial startups' location under uncertainty through a heterogeneous multi-layer decision-making approach: Evidence and application of an emerging economy. *International Journal of Entrepreneurial Behavior & Research*, 28(3), 767–800. <https://doi.org/10.1108/IJEBR-05-2021-0387>
- Razavi Hajiagha, S. H., Amoozad Mahdiraji, H., Moradi, S., Garza-Reyes, J. A., & Alaei, S. (2022b). Unveiling the relation between the challenges and benefits of operational excellence and industry 4.0: A hybrid fuzzy decision-making approach. *The TQM Journal*, ahead-of-print(ahead-of-print). <https://doi.org/10.1108/TQM-07-2022-0237>
- Reiman, A., Kaivo-oja, J., Parviainen, E., Takala, E. P., & Lauraeus, T. (2021). Human factors and ergonomics in manufacturing in the industry 4.0 context – A scoping review. *Technology in Society*, 65, 101572. <https://doi.org/10.1016/j.techsoc.2021.101572>
- Renda, A., Schwaag Serger, S., Tataj, D., Morlet, A., Isaksson, D., Martins, F., & Giovannini, E. (2022). Industry 5.0, a transformative vision for Europe: Governing systemic transformations towards a sustainable industry. *European Commission, Directorate-General for Research and Innovation*. <https://doi.org/10.2777/17322>

- Rene, E. R., Sethurajan, M., Kumar Ponnusamy, V., Kumar, G., Bao Dung, T. N., Brindhadevi, K., & Pugazhendhi, A. (2021). Electronic waste generation, recycling and resource recovery: Technological perspectives and trends. *Journal of Hazardous Materials*, 416, 125664. <https://doi.org/10.1016/j.jhazmat.2021.125664>
- Reyes, J., Mula, J., & Díaz-Madroñero, M. (2021). Development of a conceptual model for lean supply chain planning in industry 4.0: Multidimensional analysis for operations management. *Production Planning and Control*. <https://doi.org/10.1080/09537287.2021.1993373>
- Rickard, J. T., Aisbett, J., & Gibbon, G. (2008). Fuzzy subsethood for fuzzy sets of Type-2 and generalized Type-Type- $\{n\}$ . *IEEE Transactions on Fuzzy Systems*, 17(1), 50–60.
- Rikap, C. (2022). From global value chains to corporate production and innovation systems: Exploring the rise of intellectual monopoly capitalism. *Area Development and Policy*, 1–15. <https://doi.org/10.1080/23792949.2021.2025118>
- Rikap, C., & Lundvall, B. (2022). Big tech, knowledge predation and the implications for development. *Innovation and Development*, 12(3), 389–416. <https://doi.org/10.1080/2157930X.2020.1855825>
- Robert, M., Giuliani, P., & Gurau, C. (2022). Implementing industry 4.0 real-time performance management systems: The case of Schneider Electric. *Production Planning and Control*, 33(2–3), 244–260. <https://doi.org/10.1080/09537287.2020.1810761>
- Roda-Sanchez, L., Olivares, T., Garrido-Hidalgo, C., De La Vara, J. L., & Fernandez-Caballero, A. (2021). Human-robot interaction in industry 4.0 based on an internet of things real-time gesture control system. *Integrated Computer-Aided Engineering*, 28(2), 159–175. <https://doi.org/10.3233/ICA-200637>
- Rosin, F., Forget, P., Lamouri, S., & Pellerin, R. (2020). Impacts of industry 4.0 technologies on lean principles. *International Journal of Production Research*, 58(6), 1644–1661.
- Rosin, F., Forget, P., Lamouri, S., & Pellerin, R. (2021). Impact of industry 4.0 on decision-making in an operational context. *Advances in Production Engineering and Management*, 16(4), 500–514. <https://doi.org/10.14743/APEM2021.4.416>
- Sachsenmeier, P. (2016). Industry 5.0—The relevance and implications of bionics and synthetic biology. *Engineering*, 2(2), 225–229. <https://doi.org/10.1016/J.ENG.2016.02.015>
- Sallati, C., & Schützer, K. (2021). Development of smart products for elders within the industry 4.0 context: A conceptual framework. *Procedia CIRP*, 100, 810–815.
- Saniuk, S., Grabowska, S., & Gajdzik, B. Z. (2020a). Personalization of products in the industry 4.0 concept and its impact on achieving a higher level of sustainable consumption. *Energies*, 13(22). <https://doi.org/10.3390/en13225895>
- Saniuk, S., Grabowska, S., & Gajdzik, B. (2020b). Social expectations and market changes in the context of developing the industry 4.0 concept. *Sustainability*, 12(4). <https://doi.org/10.3390/su12041362>
- Scharl, S., & Praktikno, A. (2019). The role of a digital industry 4.0 in a renewable energy system. *International Journal of Energy Research*, 43(8), 3891–3904. <https://doi.org/10.1002/er.4462>
- Sharma, M., Kamble, S., Mani, V., Sehrawat, R., Belhadi, A., & Sharma, V. (2021). Industry 4.0 adoption for sustainability in multi-tier manufacturing supply chain in emerging economies. *Journal of Cleaner Production*, 281, 125013. <https://doi.org/10.1016/j.jclepro.2020.125013>
- Shayganmehr, M., Kumar, A., Garza-Reyes, J. A., & Moktadir, M. A. (2021). Industry 4.0 enablers for a cleaner production and circular economy within the context of business ethics: A study in a developing country. *Journal of Cleaner Production*, 281, 125280. <https://doi.org/10.1016/j.jclepro.2020.125280>
- Shi, Z., Xie, Y., Xue, W., Chen, Y., Fu, L., & Xu, X. (2020). Smart factory in Industry 4.0. *Systems Research and Behavioral Science*, 37(4), 607–617. <https://doi.org/10.1002/sres.2704>
- Sindhwani, R., Afridi, S., Kumar, A., Banaitis, A., Luthra, S., & Singh, P. L. (2022). Can industry 5.0 revolutionize the wave of resilience and social value creation? A multi-criteria framework to analyze enablers. *Technology in Society*, 68, 101887. <https://doi.org/10.1016/j.techsoc.2022.101887>
- Soh, C., & Connolly, D. (2020). The human security implications of the fourth industrial revolution in East Asia. *Asian Perspective*, 44(3), 383–407. <https://doi.org/10.1353/apr.2020.0017>
- Soh, C., & Connolly, D. (2021). New frontiers of profit and risk: The fourth industrial revolution's impact on business and human rights. *New Political Economy*, 26(1), 168–185. <https://doi.org/10.1080/13563467.2020.1723514>
- Song, M., Peng, L., Shang, Y., & Zhao, X. (2022). Green technology progress and total factor productivity of resource-based enterprises: A perspective of technical compensation of environmental regulation. *Technological Forecasting and Social Change*, 174, 121276.
- Soukupová, N., Adamová, M., & Krninská, R. (2020). Industry 4.0: An employee perception (case of the Czech Republic). *Acta Universitatis Agriculturae et Silviculturae Mendelianae Brunensis*, 68(3), 637–644. <https://doi.org/10.11118/actaun202068030637>
- Spieske, A., & Birkel, H. (2021). Improving supply chain resilience through industry 4.0: A systematic literature review under the impressions of the COVID-19 pandemic. *Computers and Industrial Engineering*, 158, 107452. <https://doi.org/10.1016/j.cie.2021.107452>
- Stock, T., Obenaus, M., Kunz, S., & Kohl, H. (2018). Industry 4.0 as enabler for a sustainable development: A qualitative assessment of its ecological and social potential. *Process Safety and Environmental Protection*, 118, 254–267. <https://doi.org/10.1016/j.psep.2018.06.026>
- Strandhagen, J. W., Buer, S. V., Semini, M., Alfnes, E., & Strandhagen, J. O. (2020). Sustainability challenges and how Industry 4.0 technologies can address them: A case study of a shipbuilding supply chain. *Production Planning and Control*. <https://doi.org/10.1080/09537287.2020.1837940>
- Sun, X., Yu, H., Solvang, W. D., Wang, Y., & Wang, K. (2022). The application of industry 4.0 technologies in sustainable logistics: A systematic literature review (2012–2020) to explore future research opportunities. *Environmental Science and Pollution Research*, 29(7), 9560–9591. <https://doi.org/10.1007/s11356-021-17693-y>
- Sung, T. K. (2018). Industry 4.0: A Korea perspective. *Technological Forecasting and Social Change*, 132, 40–45. <https://doi.org/10.1016/j.techfore.2017.11.005>
- Thomas, J., & Harden, A. (2008). Methods for the thematic synthesis of qualitative research in systematic reviews. *BMC Medical Research Methodology*, 8(1), 45. <https://doi.org/10.1186/1471-2288-8-45>
- Toktaş-Palut, P. (2022). Analyzing the effects of industry 4.0 technologies and coordination on the sustainability of supply chains. *Sustainable Production and Consumption*, 30, 341–358.
- Tong, S., Jia, N., Luo, X., & Fang, Z. (2021). The Janus face of artificial intelligence feedback: Deployment versus disclosure effects on employee performance. *Strategic Management Journal*, 42(9), 1600–1631.
- Torra, V., & Narukawa, Y. (2009). On hesitant fuzzy sets and decision. *2009 IEEE International Conference on Fuzzy Systems*, Jeju, Korea (South), 2009. pp. 1378–1382. <https://doi.org/10.1109/FUZZY.2009.5276884>
- Tsolakis, N., Harrington, T. S., & Srari, J. S. (2023). Digital supply network design: A circular economy 4.0 decision-making system for real-world challenges. *Production Planning & Control*, 34(10), 941–966. <https://doi.org/10.1080/09537287.2021.1980907>



- Vereycken, Y., Ramioul, M., Desiere, S., & Bal, M. (2021). Human resource practices accompanying industry 4.0 in European manufacturing industry. *Journal of Manufacturing Technology Management*, 32(5), 1016–1036. <https://doi.org/10.1108/JMTM-08-2020-0331>
- Viriyasitavat, W., Xu, D., Bi, L., & Sapsomboon, A. (2020). Block-chain-based business process management (BPM) framework for service composition in industry 4.0. *Journal of Intelligent Manufacturing*, 31(7), 1737–1748.
- Vlachos, I. P., Pascazzi, R. M., Zobolas, G., Repoussis, P., & Giannakis, M. (2021). Lean manufacturing systems in the area of industry 4.0: A lean automation plan of AGVs/IoT integration. *Production Planning and Control*. <https://doi.org/10.1080/09537287.2021.1917720>
- Wang, C.-H., & Wu, C.-L. (2021). Bridging the digital divide: The smart TV as a platform for digital literacy among the elderly. *Behaviour & Information Technology*, 1–14. <https://doi.org/10.1080/0144929X.2021.1934732>
- Watson, R. T., & Webster, J. (2020). Analysing the past to prepare for the future: Writing a literature review a roadmap for release 2.0. *Journal of Decision Systems*, 29(3), 129–147.
- Webster, J., & Watson, R. T. (2002). Analyzing the past to prepare for the future: Writing a literature review. *MIS Quarterly*, 26(2), xiii–xxiii.
- Wei, Z., & Peters, M. A. (2019). ‘Intelligent capitalism’ and the disappearance of labour: Whitherto education? *Educational Philosophy and Theory*, 51(8), 757–766. <https://doi.org/10.1080/00131857.2018.1519775>
- White, M. D., & Marsh, E. E. (2006). Content analysis: A flexible methodology. *Library Trends*, 55(1), 22–45.
- Xie, Y., Yin, Y., Xue, W., Shi, H., & Chong, D. (2020). Intelligent supply chain performance measurement in Industry 4.0. *Systems Research and Behavioral Science*, 37(4), 711–718. <https://doi.org/10.1002/sres.2712>
- Xu, X., Lu, Y., Vogel-Heuser, B., & Wang, L. (2021). Industry 4.0 and industry 5.0— inception, conception and perception. *Journal of Manufacturing Systems*, 61, 530–535.
- Yalcin, E., Arslan, O., & Aymelek, M. (2020). Developing a policy management algorithm for ship provision: A Delphi technique integrated with hesitant fuzzy set (DTHFS) approach. *Maritime Policy & Management*, 47(8), 1097–1118.
- Yilmaz, A., Dora, M., Hezarkhani, B., & Kumar, M. (2022). Lean and industry 4.0: Mapping determinants and barriers from a social, environmental, and operational perspective. *Technological Forecasting and Social Change*, 175, 121320. <https://doi.org/10.1016/j.techfore.2021.121320>
- Zadeh, L. A. (2011). A note on Z-numbers. *Information Sciences*, 181(14), 2923–2932.
- Zhang, A., Venkatesh, V. G., Wang, J. X., Mani, V., Wan, M., & Qu, T. (2021). Drivers of industry 4.0-enabled smart waste management in supply chain operations: A circular economy perspective in China. *Production Planning and Control*. <https://doi.org/10.1080/09537287.2021.1980909>

**Publisher’s Note** Springer Nature remains neutral with regard to jurisdictional claims in published maps and institutional affiliations.

**Dr. Morteza Ghobakhloo** is an Associate Professor at Uppsala University, Sweden, specializing in Industrial Engineering and Management. His expertise lies in digitalization strategic management, focusing on digital industrial transformation in the Industry 4.0 and Industry 5.0 eras. He is renowned for his research on hyper-connected production ecosystems and corporate sustainability performance. With a Ph.D. in Industrial Engineering, he has led numerous national and international

research projects on digitalization, corporate sustainability, and industrial transformation. He is also sought after as a digitalization consultant by leading businesses worldwide. His research contributions have been published in prestigious journals such as BSE, IJPR, TFSC, and JCLP.

**Hannan Amoozad Mahdiraji** PhD, is an Associate Professor in Business Analytics at Birmingham Business School, University of Birmingham. Previously, he was a Lecturer in Strategy and Business Analytics and the Programme Leader at the School of Business, University of Leicester. Before, he was a Senior Lecturer in Business and Management at De Montfort University, Lecturer in Operations and Supply Chain Management at the School of Strategy and Leadership at Coventry University, and Assistant Professor in Management Science at the Faculty of Management, University of Tehran. He graduated with his PhD in Management Science in 2012 from the University of Tehran. His primary interest areas include multiple-criteria decision-making (MCDM) methods, game theory (GT), and supply chain management (SCM). Since 2011, he has published several research papers in respected international journals, including the British Journal of Management, Risk Analysis: An International Journal, Journal of Operational Research Society, Technological Forecasting and Social Change, Journal of Business Research, Computers and Industrial Engineering, Expert Systems with Applications, Cleaner Production, and Operations Research Letters. He has also participated in and presented articles at prestigious international conferences such as the Academy of Management and the Academy of International Business. Furthermore, he has published one book in Springer, focusing on the applications of Management Science in international entrepreneurs decision-making.

**Mohammad Iranmanesh** is an Associate Professor attached to the La Trobe Business School, La Trobe University. His research interests are at the interface of sustainability and Information Systems (IS), focusing on issues related to digital transformation, sustainable manufacturing, and sustainable development. He has published more than 100 articles in a range of leading academic journals and conferences. Mohammad was named in the Top 40 Australia’s early achievers (Rising Stars) of 2020 by research cited in The Australian newspaper.

**Dr. Vahid Jafari-Sadeghi** (SFHEA) is a Senior Lecturer in International Business and the Director of the PhD Programme at Aston Business School. Before joining Aston University, Vahid was a Senior Lecturer in International Entrepreneurship at the Newcastle Business School, Northumbria University, and a Lecturer in Business Strategy at the School of Strategy and Leadership at Coventry University. He is a member of the executive board of the Academy of International Business UK & Ireland Chapter (AIB-UKI) and is an active researcher in international entrepreneurship, particularly in the area of SME internationalisation. Vahid is the chair of the 50th AIB UK & Ireland Chapter Conference (2024) and a member of the organisation committee of The Institute for Small Business and Entrepreneurship (ISBE) 2023 conference, hosted by Aston Business School. He has published papers in leading international journals such as the British Journal of Management, Risk Analysis, International Business Review, Journal of Business Research, Technological Forecasting and Social Change, Journal of International Entrepreneurship, etc. Dr Jafari-Sadeghi is an associate editor at the EuroMed Journal of Business, and a member of the editorial board of The International Journal of Entrepreneurship and Innovation, International Journal of Entrepreneurship and Small Business, International Journal of Business and Globalisation, and British Food Journal. He has served as the lead guest editor for special issues at the International Journal of Entrepreneurial Behavior & Research, Journal of Enterprise Information Management, Journal of Theoretical and Applied Electronic Commerce Research, and British Food Journal. Vahid has edited various books in Springer, Routledge, and Emerald and performed as track chair and presenter for several international conferences.

## Authors and Affiliations

Morteza Ghobakhloo<sup>1,2</sup>  · Hannan Amoozad Mahdiraji<sup>3</sup> · Mohammad Iranmanesh<sup>4</sup> · Vahid Jafari-Sadeghi<sup>5</sup>

✉ Morteza Ghobakhloo  
morteza.ghobakhloo@angstrom.uu.se;  
morteza\_ghobakhloo@yahoo.com

✉ Vahid Jafari-Sadeghi  
v.jafari-sadeghi@aston.ac.uk

Hannan Amoozad Mahdiraji  
h.m.amoozad@bham.ac.uk

Mohammad Iranmanesh  
m.iranmanesh@latrobe.edu.au

<sup>2</sup> School of Economics and Business, Kaunas University of Technology, Kaunas, Lithuania

<sup>3</sup> Birmingham Business School, University of Birmingham, Birmingham, UK

<sup>4</sup> La Trobe Business School, La Trobe University, Melbourne, VIC, Australia

<sup>5</sup> Aston Business School, Aston University, Birmingham B4 7ET, UK

<sup>1</sup> Division of Industrial Engineering and Management, Uppsala University, P.O. Box 534, Uppsala 75121, Sweden