

Hafnium and zirconium diboride containing ceramics

Binner, Jon; Hillman, William

Document Version

Publisher's PDF, also known as Version of record

Citation for published version (Harvard):

Binner, J & Hillman, W Oct. 22 2020, *Hafnium and zirconium diboride containing ceramics*, Patent No. WO2020/212692 A1.

[Link to publication on Research at Birmingham portal](#)

General rights

Unless a licence is specified above, all rights (including copyright and moral rights) in this document are retained by the authors and/or the copyright holders. The express permission of the copyright holder must be obtained for any use of this material other than for purposes permitted by law.

- Users may freely distribute the URL that is used to identify this publication.
- Users may download and/or print one copy of the publication from the University of Birmingham research portal for the purpose of private study or non-commercial research.
- User may use extracts from the document in line with the concept of 'fair dealing' under the Copyright, Designs and Patents Act 1988 (?)
- Users may not further distribute the material nor use it for the purposes of commercial gain.

Where a licence is displayed above, please note the terms and conditions of the licence govern your use of this document.

When citing, please reference the published version.

Take down policy

While the University of Birmingham exercises care and attention in making items available there are rare occasions when an item has been uploaded in error or has been deemed to be commercially or otherwise sensitive.

If you believe that this is the case for this document, please contact UBIRA@lists.bham.ac.uk providing details and we will remove access to the work immediately and investigate.



- (51) **International Patent Classification:**
C04B 35/58 (2006.01) *C04B 35/626* (2006.01)
C04B 35/80 (2006.01)
- (21) **International Application Number:**
PCT/GB2020/050951
- (22) **International Filing Date:**
14 April 2020 (14.04.2020)
- (25) **Filing Language:** English
- (26) **Publication Language:** English
- (30) **Priority Data:**
1905296.8 15 April 2019 (15.04.2019) GB
- (71) **Applicant: THE UNIVERSITY OF BIRMINGHAM** [GB/GB]; Edgbaston, Birmingham West Midlands B15 2TT (GB).
- (72) **Inventors: BINNER, Jon;** c/o University of Birmingham, School of Metallurgy & Materials, Edgbaston, Birmingham West Midlands B15 2TT (GB). **HILLMAN, William;** c/o University of Birmingham Enterprise Limited, Birmingham Research Park, Vincent Drive, Birmingham West Midlands B15 2SQ (GB).
- (74) **Agent: HGF LTD;** Document Handling - HGF (Birmingham), 1 City Walk, Leeds Yorkshire LS11 9DX (GB).
- (81) **Designated States** (unless otherwise indicated, for every kind of national protection available): AE, AG, AL, AM, AO, AT, AU, AZ, BA, BB, BG, BH, BN, BR, BW, BY, BZ, CA, CH, CL, CN, CO, CR, CU, CZ, DE, DJ, DK, DM, DO, DZ, EC, EE, EG, ES, FI, GB, GD, GE, GH, GM, GT, HN, HR, HU, ID, IL, IN, IR, IS, JO, JP, KE, KG, KH, KN, KP, KR, KW, KZ, LA, LC, LK, LR, LS, LU, LY, MA, MD, ME, MG, MK, MN, MW, MX, MY, MZ, NA, NG, NI, NO, NZ, OM, PA, PE, PG, PH, PL, PT, QA, RO, RS, RU, RW, SA, SC, SD, SE, SG, SK, SL, ST, SV, SY, TH, TJ, TM, TN, TR, TT, TZ, UA, UG, US, UZ, VC, VN, WS, ZA, ZM, ZW.
- (84) **Designated States** (unless otherwise indicated, for every kind of regional protection available): ARIPO (BW, GH, GM, KE, LR, LS, MW, MZ, NA, RW, SD, SL, ST, SZ, TZ, UG, ZM, ZW), Eurasian (AM, AZ, BY, KG, KZ, RU, TJ, TM), European (AL, AT, BE, BG, CH, CY, CZ, DE, DK, EE, ES, FI, FR, GB, GR, HR, HU, IE, IS, IT, LT, LU, LV, MC, MK, MT, NL, NO, PL, PT, RO, RS, SE, SI, SK, SM, TR), OAPI (BF, BJ, CF, CG, CI, CM, GA, GN, GQ, GW, KM, ML, MR, NE, SN, TD, TG).

(54) **Title:** HAFNIUM AND ZIRCONIUM DIBORIDE CONTAINING CERAMICS

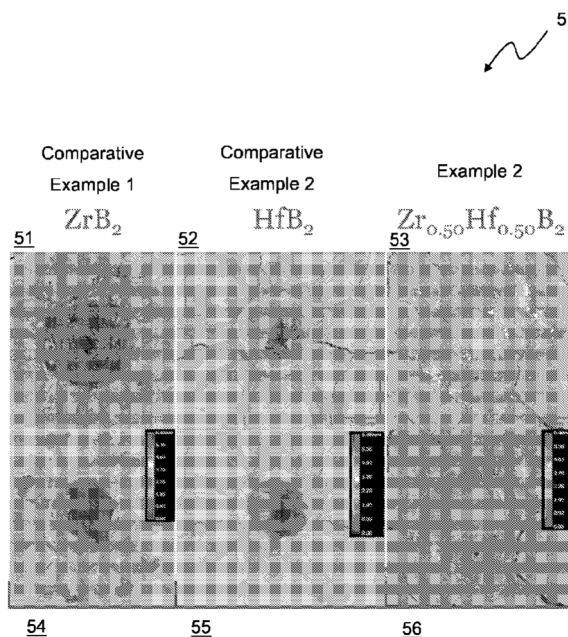

FIGURE 5

(57) **Abstract:** An ultra-high temperature ceramic material comprises hafnium diboride and zirconium diboride. The article preferably comprises a substrate material into which the hafnium diboride and zirconium diboride are impregnated.



Published:

— *with international search report (Art. 21(3))*

HAFNIUM AND ZIRCONIUM DIBORIDE CONTAINING CERAMICS

This invention relates generally to ceramic materials. More specifically, although not exclusively, this invention relates to ceramic materials for use in ultra-high temperature applications, and methods of making the same.

Ultra-high temperature ceramics (UHTCs) are candidate materials for hypersonic flight, atmospheric re-entry vehicles and thermal protection systems (TPS) for rocket nozzles as they typically possess good chemical stability, high thermal conductivity, high strength and melting points over 3000 °C.

Monolithic UHTCs are known. However, under extreme conditions, these monolithic materials may be brittle and may fail when exposed to sudden high heat fluxes. Therefore, UHTCs are often created within a carbon fibre matrix to produce ceramic matrix composites (UHT-CMCs). This may improve the thermal shock resistance and toughness. In addition, UHT-CMCs are less dense (and hence less weighty), which is beneficial for fuel efficiency when used as components in vehicles.

It is known to use either zirconium diboride (ZrB_2) or hafnium diboride (HfB_2) in UHTCs. For example, US 5,750,450 describes the fabrication of high temperature ablation resistant ceramic composites comprising zirconium diboride or hafnium diboride as a component of a UHTC. The UHTC of this patent comprises silicon carbide, a metal diboride (e.g. zirconium diboride) and a metal carbide (e.g. hafnium carbide).

Despite the high melting points of ZrB_2 and HfB_2 being >3000 °C, these UHTCs oxidise to ZrO_2 and HfO_2 around ~700 °C and ~800 °C respectively. Beneficially, in a low temperature regime (~450 °C and above) the *in-situ* formation of molten B_2O_3 inhibits the diffusion of oxygen and prevents further oxidation of the bulk material. This enables the bulk material in the UHTC to retain a high melting point and those associated beneficial properties. However, above ~1100 °C, the molten B_2O_3 vaporises from the surface of the UHTC and at ~1800 °C, the liquid vaporises as quickly as it forms and so the protection mechanism is lost.

Although carbon fibres (Cf) also oxidise at ~500 °C, Cf composites containing either ZrB_2 or HfB_2 display significantly improved oxidation and ablation resistance compared to C/C composites, which are currently used in rocket nozzles (Makurunje et. al., *J. Eur. Ceram.*

Soc. **2017**, 37(10):3227–39). It is known that chemical and mechanical erosion of a nozzle throat comprising a C/C composite limits the capabilities of the rocket by reducing the pressure differential and hence the amount of thrust (Thakre et. al., *J. Propuls. Power*, **2013**, 29(3):593–601; Bianchi et. al., *J Propuls. Power*. **2013**, 29(5). Accordingly, the reduction of such erosion is important.

Composites comprising carbon fibre and hafnium diboride (Cf/HfB₂ composites) have been demonstrated to withstand temperatures as high as ~3000 °C combined with heat fluxes up to 17 MW m⁻² and gas velocities of Mach 0.60 ± 0.05 (Paul et. al., *Adv. Appl. Ceram.* **2016**;115(3):158–65).

Composites comprising carbon fibre and zirconium diboride (Cf/ZrB₂ composites) also display desirable properties, being lower in density (6.09 versus 10.5 gcm⁻³), an order of magnitude cheaper in price and able to resist temperatures of ~2700 °C. This is beneficial since aerospace materials are needed that will allow leading edges to remain sharp or rocket nozzles to resist ablation.

It has also been shown that ultra-high temperature C-C composites formed from monomer-based ZrB₂-SiC powders produce an oxidation-resistant glass-ceramic coating *in situ* at high temperatures, which provides a protective oxygen diffusion barrier at high temperatures (Walker et. al., *J. Am. Ceram. Soc.*, 97 [9] 3004-3011 (2014)).

In addition, composites comprising zirconium carbide (ZrC) and silicon carbide (SiC) have been shown to provide excellent oxidation resistance. During testing at temperatures above 1100 °C, the formation of SiO₂ may even flow into cracks to repair the matrix. It has been found that as the temperature increases, the ablation rate is controlled by the vaporisation of the melt (Chen et. al., *Corros. Sci.* **2013**, 68:168–75).

Nevertheless, materials that display even greater performance characteristics are sought since the conditions that must be withstood are constantly increasing.

It is therefore a first non-exclusive object of the invention to provide a material, e.g. an ultra-high temperature ceramic, with better performance characteristics at temperatures above 1000 °C, e.g. above 2000 °C or above 3000 °C, than those of the prior art.

Accordingly, a first aspect of the invention provides an ultra-high temperature ceramic material comprising hafnium diboride and zirconium diboride.

5 The term “ultra-high temperature” ceramic material is defined in this specification to mean a ceramic material that is stable at temperatures above 2000 °C, e.g. above 2500 °C and/or above 3000 °C.

The ceramic material may comprise a mixture, for example an intimate (*e.g.* substantially homogeneous) mixture of hafnium diboride and zirconium diboride.

10

The ceramic material may be monolithic.

In an alternative embodiment, the ceramic material may further comprise a substrate or a reinforcing component. The substrate or reinforcing component may comprise or be a porous body. The substrate or reinforcing component may be formed from a fibre component, e.g. a carbon fibre, to form a composite. The ceramic material may form a matrix with the substrate or reinforcing component, e.g. a fibre reinforcing component. In 15 embodiments, the ceramic material may be a carbon fibre reinforced ceramic composite.

20 In embodiments, the substrate may comprise or be a preform. We define the term “preform” to mean a substrate that has a three dimensional shape before it is contacted with the ceramic material. The preform then retains the same three dimensional shape to form the ceramic material comprising the preform.

25 The preform may be a porous body. The preform may be fabricated from carbon, e.g. a carbon fibre preform. In embodiments, the ceramic material may be impregnated into the substrate. In embodiments, the ceramic material may be coated onto the substrate.

30 In embodiments, the ceramic material does not comprise silicon or compounds of silicon, e.g. silicon carbide, other than unavoidable impurities.

A further aspect of the invention provides an ultra-high temperature ceramic material comprising a heat resistant component, the heat resistant component comprising:

between 15 to 85 vol.% HfB₂; and

35

between 15 to 85 vol.% ZrB₂.

In embodiments, the heat resistant component may comprise between 25 to 75 vol.% HfB₂ and 25 to 75 vol.% ZrB₂. For example, the heat resistant component may comprise between from any one of 25, 26, 27, 28, 29, 30, 31, 32, 33, 34, 35, 36, 37, 38, 39, 40, 41, 42, 43, 44,
5 45, 46, 47, 48, 49, 50, 51, 52, 53, 54, 55, 56, 57, 58, 59, 60, 61, 62, 63, 64, 65, 66, 67, 68, 69, 70, 71, 72, 73, 74, 75 vol.% to any one of 75, 74, 73, 72, 71, 70, 69, 68, 67, 66, 65, 64, 63, 62, 61, 60, 59, 58, 57, 56, 55, 54, 53, 52, 51, 50, 49, 48, 47, 46, 45, 44, 43, 42, 41, 40, 39, 38, 37, 36, 35, 34, 33, 32, 31, 30, 29, 28, 27, 26, 25 vol.% HfB₂ and between from any one of 25, 26, 27, 28, 29, 30, 31, 32, 33, 34, 35, 36, 37, 38, 39, 40, 41, 42, 43, 44, 45, 46,
10 47, 48, 49, 50, 51, 52, 53, 54, 55, 56, 57, 58, 59, 60, 61, 62, 63, 64, 65, 66, 67, 68, 69, 70, 71, 72, 73, 74, 75 vol.% to any one of 75, 74, 73, 72, 71, 70, 69, 68, 67, 66, 65, 64, 63, 62, 61, 60, 59, 58, 57, 56, 55, 54, 53, 52, 51, 50, 49, 48, 47, 46, 45, 44, 43, 42, 41, 40, 39, 38, 37, 36, 35, 34, 33, 32, 31, 30, 29, 28, 27, 26, 25 vol.% ZrB₂.

15 In embodiments, the heat resistant component may comprise between 50 to 75 vol.% HfB₂ and 50 to 25 vol.% ZrB₂. In embodiments, the heat resistant component may comprise more than 50 to 75 vol.% HfB₂ and less than 50 to 25 vol.% ZrB₂.

In embodiments, the heat resistant component may comprise between any one of 51, 52,
20 53, 54, 55, 56, 57, 58, 59, 60, 61, 62, 63, 64, 65, 66, 67, 68, 69, 70, 71, 72, 73, 74 % to any one of 75, 74, 73, 72, 71, 70, 69, 68, 67, 66, 65, 64, 63, 62, 61, 60, 59, 58, 57, 56, 55, 54, 53, 52 vol.% HfB₂ and between any one of 49, 48, 47, 46, 45, 44, 43, 42, 41, 40, 39, 38, 37, 36, 35, 34, 33, 32, 31, 30, 29, 28, 27, 26 % to any one of 25, 26, 27, 28, 29, 30, 31, 32, 33, 34, 35, 36, 37, 38, 39, 40, 41, 42, 43, 44, 45, 46, 47, 48 vol.% ZrB₂.

25 In embodiments, the heat resistant component may comprise between 55 to 75 vol.% HfB₂ and 45 to 25 vol.% ZrB₂. For example, the heat resistant component may comprise between 60 to 75 vol.% HfB₂ and 40 to 25 vol.% ZrB₂, or between 65 to 75 vol.% HfB₂ and 35 to 25 vol.% ZrB₂, or between 70 to 75 vol.% HfB₂ and 30 to 25 vol.% ZrB₂.

30 In embodiments, the heat resistant component consists of HfB₂ and ZrB₂.

The ratio of hafnium diboride to zirconium diboride may be the same or may vary across and/or through the ceramic material. For example, the ceramic material may comprise a
35 first zone or region where there is a preponderance of hafnium diboride and a second region

where there is a preponderance of zirconium diboride and/or a third region where there is an equal ration of hafnium diboride and zirconium diboride.

A yet further aspect of the invention provides an ultra-high temperature ceramic matrix composite, the composite comprising a ceramic matrix component and a reinforcing component, the ceramic matrix component comprising a heat resistant component, the heat resistant component comprising:

between 15 to 85 vol.% HfB₂; and

between 15 to 85 vol.% ZrB₂.

10

In embodiments, the heat resistant component may comprise between 25 to 75 vol.% HfB₂ and 25 to 75 vol.% ZrB₂. For example, the heat resistant component may comprise between from any one of 25, 26, 27, 28, 29, 30, 31, 32, 33, 34, 35, 36, 37, 38, 39, 40, 41, 42, 43, 44, 45, 46, 47, 48, 49, 50, 51, 52, 53, 54, 55, 56, 57, 58, 59, 60, 61, 62, 63, 64, 65, 66, 67, 68, 69, 70, 71, 72, 73, 74, 75 vol.% to any one of 75, 74, 73, 72, 71, 70, 69, 68, 67, 66, 65, 64, 63, 62, 61, 60, 59, 58, 57, 56, 55, 54, 53, 52, 51, 50, 49, 48, 47, 46, 45, 44, 43, 42, 41, 40, 39, 38, 37, 36, 35, 34, 33, 32, 31, 30, 29, 28, 27, 26, 25 vol.% HfB₂ and between from any one of 25, 26, 27, 28, 29, 30, 31, 32, 33, 34, 35, 36, 37, 38, 39, 40, 41, 42, 43, 44, 45, 46, 47, 48, 49, 50, 51, 52, 53, 54, 55, 56, 57, 58, 59, 60, 61, 62, 63, 64, 65, 66, 67, 68, 69, 70, 71, 72, 73, 74, 75 vol.% to any one of 75, 74, 73, 72, 71, 70, 69, 68, 67, 66, 65, 64, 63, 62, 61, 60, 59, 58, 57, 56, 55, 54, 53, 52, 51, 50, 49, 48, 47, 46, 45, 44, 43, 42, 41, 40, 39, 38, 37, 36, 35, 34, 33, 32, 31, 30, 29, 28, 27, 26, 25 vol.% ZrB₂.

15

20

In embodiments, the heat resistant component may comprise between 50 to 75 vol.% HfB₂ and 50 to 25 vol.% ZrB₂. In embodiments, the heat resistant component may comprise more than 50 to 75 vol.% HfB₂ and less than 50 to 25 vol.% ZrB₂.

25

In embodiments, the heat resistant component may comprise between any one of 51, 52, 53, 54, 55, 56, 57, 58, 59, 60, 61, 62, 63, 64, 65, 66, 67, 68, 69, 70, 71, 72, 73, 74 % to any one of 75, 74, 73, 72, 71, 70, 69, 68, 67, 66, 65, 64, 63, 62, 61, 60, 59, 58, 57, 56, 55, 54, 53, 52 vol.% HfB₂ and between any one of 49, 48, 47, 46, 45, 44, 43, 42, 41, 40, 39, 38, 37, 36, 35, 34, 33, 32, 31, 30, 29, 28, 27, 26 % to any one of 25, 26, 27, 28, 29, 30, 31, 32, 33, 34, 35, 36, 37, 38, 39, 40, 41, 42, 43, 44, 45, 46, 47, 48 vol.% ZrB₂.

30

In embodiments, the heat resistant component may comprise between 55 to 75 vol.% HfB₂ and 45 to 25 vol.% ZrB₂. For example, the heat resistant component may comprise between 60 to 75 vol.% HfB₂ and 40 to 25 vol.% ZrB₂, or between 65 to 75 vol.% HfB₂ and 35 to 25 vol.% ZrB₂, or between 70 to 75 vol.% HfB₂ and 30 to 25 vol.% ZrB₂.

5

The reinforcing component may comprise a substrate, for example a porous body and/or a preform. The reinforcing component may be fabricated in whole or part from a fibre component, e.g. a carbon fibre component.

10 It has been surprisingly found that the dynamic oxidation of the ceramic material and ceramic matrix composite according to the invention at ultra-high temperatures, e.g. >2700 °C, is limited by including a mixture comprising both hafnium diboride and zirconium diboride. This minimises damage to the ceramic material and/or ceramic matrix composite.

15 Although it is to be expected that a combination of HfB₂ and ZrB₂ would give rise to a composite with equal performance to those containing one or the other, it has been surprisingly found that the effect of having mixed hafnium and zirconium diborides is synergistic.

20 Without wishing to be bound by any theory, our evidence demonstrates that damage to an article can be at least reduced, e.g. significantly reduced, using the combination of zirconium and hafnium boride. The combination can prevent oxidative damage, e.g. oxidative damage of the vulnerable carbon fibres in a CMC according to the invention. We have demonstrated that damage of the ceramic material at high temperatures, e.g. above
25 2800 °C is reduced. The effect is synergistic in comparison to the use of ZrB₂ alone or HfB₂ alone rather than in combination, according to the invention.

A yet further aspect of the invention provides a method of fabricating an ultra-high temperature ceramic matrix composite, the method comprising:

- 30 (a) providing a substrate;
- (b) providing a composition comprising a heat resistant component, the heat resistant component comprising HfB₂ and ZrB₂;
- (c) impregnating the substrate with the composition;
- (d) optionally, curing the substrate comprising the composition to form a ceramic matrix
35 within the substrate;

(e) pyrolyzing the substrate comprising the ceramic matrix.

In embodiments, the substrate may be a porous body and/or a preform. The substrate may be formed from or may comprise fibres, e.g. carbon fibres.

5

In embodiments, the composition may comprise a resin, for example a phenolic resin and/or a solvent, for example acetone.

10

In embodiments, the heat resistant component may comprise between 15 to 85 vol.% HfB₂ and between 15 to 85 vol.% ZrB₂.

15

In embodiments, impregnating the substrate may comprise injecting the composition into the substrate. In embodiments, impregnating the substrate may comprise impregnating the substrate with the composition under vacuum. In embodiments, impregnating the substrate may comprise a two-stage pressure assisted impregnation technique comprising: (i) injecting the composition into the substrate; and (ii) supplying a vacuum to the substrate in the presence of the composition to impregnate of the substrate with the composition. In embodiments, step (i) injecting the composition into the substrate, may be performed before step (ii) supplying a vacuum to the substrate in the presence of the composition to impregnate of the substrate with the composition.

20

For the avoidance of doubt, any of the features described herein apply equally to any aspect of the invention.

25

Within the scope of this application it is expressly intended that the various aspects, embodiments, examples and alternatives set out in the preceding paragraphs, in the claims and/or in the following description and drawings, and in particular the individual features thereof, may be taken independently or in any combination. That is, all embodiments and/or features of any embodiment can be combined in any way and/or combination, unless such features are incompatible. For the avoidance of doubt, the terms "may", "and/or", "e.g.", "for example" and any similar term as used herein should be interpreted as non-limiting such that any feature so-described need not be present. Indeed, any combination of optional features is expressly envisaged without departing from the scope of the invention, whether or not these are expressly claimed. The applicant reserves the right to change any

30

35

originally filed claim or file any new claim accordingly, including the right to amend any

originally filed claim to depend from and/or incorporate any feature of any other claim although not originally claimed in that manner.

Examples

5 To further exemplify the invention, reference is made to the following non-limiting Examples and with reference to the accompanying drawings in which:

Figure 1A is a flow diagram illustrating the process for fabricating a ceramic matrix composite according to embodiments of the invention;

10 Figure 1B is a micro-CT image of the carbon fibre preform as supplied, which was used in the process shown in Figure 1A;

Figure 2 is an apparatus for high temperature performance testing of ceramic matrix composites according to Examples and Comparative Examples of the invention;

15 Figure 3A shows images of the ultra-high temperature test results for the ceramic matrix composite of Comparative Example 1;

Figure 3B shows images of the ultra-high temperature test results for the ceramic matrix composite of Example 1 of the invention;

Figure 3C shows images of the ultra-high temperature test results for the ceramic matrix composite of Example 2 of the invention;

20 Figure 3D shows images of the ultra-high temperature test results for the ceramic matrix composite of Example 3 of the invention;

Figure 3E shows images of the ultra-high temperature test results for the ceramic matrix composite of Comparative Example 2;

25 Figure 4 is a plot to quantitatively illustrate the results of the ultra-high temperature test results shown in Figures 3A to 3E;

Figure 5 shows a series of images of further ultra-high temperature test results for the ceramic matrix composite of Example 2 of the invention, and Comparative Examples 1 and 2;

30 Figures 6A and 6B show experimental data obtained using an aerodynamic levitation (ADL) technique to investigate the mechanism of protection for the invention.

In all Examples, zirconium diboride was obtained from H.C. Starck GmbH, Germany, hafnium diboride was obtained from Treibacher Industrie AG, Austria, and the phenolic resin was obtained from Cellobond J2027L, Hexion Speciality Chemicals, B.V. Netherlands.

35 The porous carbon fibre preforms were obtained from Surface Transforms Plc., Cheshire,

UK with the following specification provided by the manufacturer: 2.5 D (2.5 dimensional) panox carbon fibre preforms with a fibre content of ~23 vol.% (~77 vol.% porosity) and an average fibre diameter of 7-10 μm .

5 **Fabrication of Ceramic Matrix Composites (CMCs) according to Examples and Comparative Examples of the Invention**

Ceramic matrix composites (CMCs) comprising a heat resistant component were fabricated according to Examples of the invention and Comparative Examples. The heat resistant component used in each of the Examples and Comparative Examples consists of the
10 following composition, shown in Table 1.

Table 1 Composition of the heat resistant component of the CMCs of Examples of the invention			
Composition	Example	ZrB₂ (vol.%)	HfB₂ (vol.%)
1	CE 1	100	0
2	1	75	25
3	2	50	50
4	3	25	75
5	CE 2	0	100

Referring now to Figure 1A, there is shown a flow diagram 1 illustrating the fabrication
15 process according to embodiments of the invention, to produce CMCs according to Examples of the invention. Referring also to Figure 1B, there is shown a micro-CT image of the carbon fibre preform as supplied. In the process of Figure 1A, there is shown the following steps: (1a) Cut porous carbon fibre preform of Figure 1B to the desired size; (1b) Prepare slurry of ZrB₂, HfB₂, phenolic resin, and acetone; (2) Slurry injection impregnation
20 of carbon fibre preform; (3) Cure and pyrolyse carbon fibre preform; (4) Pressure-assisted impregnation of carbon fibre preform; (5) Cure and pyrolyse carbon fibre preform.

The slurry of Step (1b) was prepared using 20-30g phenolic resin, 40-60g acetone, 0-225g HfB₂ and 0-130g ZrB₂. A slurry of this description was used for each impregnation stage
25 described in Step (2) and Step (4) of the process of Figure 1A.

The curing of the carbon fibre preform of Step (3) and Step (5) was performed at 120 °C for 2 hours.

The pressure used in Step (4) of the process was between 5 to 20 mBar.

5 Some of the experimental details of Steps (2) and (4) are further described in 'Evaluation of the high temperature performance of UHTC composites', Paul A, Rubio V, Binner JGP, Vaidhyanathan B, Heaton ACJ and Brown PM, *Int. J. Appl. Ceram. Tech.* **14** [3] 344-353 (2017) and Hu et. al in *J Am Ceram Soc.* **2019**; 102:70-78 (DOI: 10.1111/jace.16018). Further details are provided in a journal article entitled "Development of a slurry injection technique for continuous fibre ultra-high temperature ceramic matrix composites (UHTCMCs)" Jon Binner *et al.* (*J Eur. Ceram. Soc.* **2019**; 39:14, 3927-3937).

The fabrication process shown in Figure 1A was used to fabricate CMCs according to the following Examples of the invention. The fabrication process was also used to prepare CMCs according to Comparative Examples, wherein Step (1b) was modified such that ZrB₂ (CE1) or HfB₂ (CE2) replaced a mixture of ZrB₂ or HfB₂ according to the invention.

It was found that the total mass uptake by the carbon fibre preforms ranged from between 20g to 40g across all compositions.

20 **Example 1 to 3: Fabrication of a Ceramic Matrix Composite comprising Composition 2 to 4 respectively**

A slurry was formed from Composition 1, 2, or 3 (20 vol.%), phenolic resin (20 vol.%) and acetone (60 vol.%). The slurry was ball milled for 24 hours before use to ensure homogenous mixing and complete dissolution of the resin in the acetone. The slurries were then impregnated into a cylindrical porous carbon fibre preform (30 mm diameter, 18 mm tall 2.5D), using a two-stage impregnation technique similar to that described in Hu et. al in *J Am Ceram Soc.* **2019**; 102:70-78 (DOI: 10.1111/jace.16018) and in the journal article described above (*J Eur. Ceram. Soc.* **2019**; 39:14, 3927-3937) comprising a slurry injection impregnation stage and a pressure assisted impregnation stage. After each impregnation stage, the carbon fibre preform was pyrolysed in flowing argon gas at 850 °C for 3 hours (heating and cooling ramp rates of 1.5 °C min⁻¹) to remove the organics residing in the phenolic resin and convert it into pyrolytic carbon. The porosity of the carbon fibre preform was reduced from the initial value of 77% to 45±5% to form a CMC according to Example 1, 2, and 3 of the invention respectively.

Comparative Example 1: Fabrication of a Ceramic Matrix Composite comprising Composition 1

A slurry was formed from ZrB_2 powder (20 vol.%), phenolic resin (20 vol.%) and acetone (60 vol.%). The slurry was ball milled for 24 hours before use to ensure homogenous mixing and complete dissolution of the resin in the acetone. The slurries were then impregnated into a cylindrical porous carbon fibre preform (30 mm diameter, 18 mm tall 2.5D), using a two-stage pressure assisted impregnation technique described in Hu et. al in *J Am Ceram Soc.* **2019**; 102:70-78 (DOI: 10.1111/jace.16018) and in the journal article described above (*J Eur. Ceram. Soc.* **2019**; 39:14, 3927-3937) comprising a slurry injection impregnation stage and a pressure assisted impregnation stage. After each impregnation stage, the carbon fibre preform was pyrolysed in flowing argon gas at 850 °C for 3 hours (heating and cooling ramp rates of 1.5 °C min⁻¹) to remove the organics residing in the phenolic resin and convert it into pyrolytic carbon. The porosity of the carbon fibre preform was reduced from the initial value of 77% to 46±3% to form a CMC according to Comparative Example 1.

Comparative Example 2: Fabrication of a Ceramic Matrix Composite comprising Composition 5

A slurry was formed from HfB_2 powder (20 vol.%), phenolic resin (20 vol.%) and acetone (60 vol.%). The slurry was ball milled for 24 hours before use to ensure homogenous mixing and complete dissolution of the resin in the acetone. The slurries were then impregnated into a cylindrical porous carbon fibre preform (30 mm diameter, 18 mm tall 2.5D), using a two-stage pressure assisted impregnation technique described in Hu et. al in *J Am Ceram Soc.* **2019**; 102:70-78 (DOI: 10.1111/jace.16018) and in the journal article described above (*J Eur. Ceram. Soc.* **2019**; 39:14, 3927-3937) comprising a slurry injection impregnation stage and a pressure assisted impregnation stage. After each impregnation stage, the carbon fibre preform was pyrolysed in flowing argon gas at 850 °C for 3 hours (heating and cooling ramp rates of 1.5 °C min⁻¹) to remove the organics residing in the phenolic resin and convert it into pyrolytic carbon. The porosity of the carbon fibre preform was reduced from the initial value of 77% to 46±3 to form a CMC according to Comparative Example 2.

High-Temperature Performance Testing of Ceramic Matrix Composites (CMCs) according to Examples and Comparative Examples of the Invention

The CMCs according to Examples 1 to 3, and Comparative Examples 1 and 2, were tested to determine the high-temperature performance using an oxyacetylene torch capable of reaching ~2950 °C.

Referring now to Figure 2, there is shown an apparatus 2 for testing the high temperature performance of the CMCs of Examples 1 to 3, and the Comparative Examples 1 and 2. The apparatus 2 comprises a back face thermocouple 21, a water cooling system 22, a sample holder 23, a guide rail 24, protective insulation 25, an oxyacetylene torch 26, a neutral density filter 27, a thermal imaging camera 28, and a two colour pyrometer 29.

A sample S, e.g. the CMC of Example 1, 2, or 3, or the CMC of Comparative Example 1 or 2, is held in the sample holder 23.

In use, the sample S is clamped in the sample holder 23. A major surface of the sample S is located at 90 degrees to the flame of the oxyacetylene torch 26 at a distance of 12 mm. The oxyacetylene torch 26 is used to heat the sample S to ~2800±50 °C with a peak heat flux of ~17 MW m⁻² for 60±0.05 seconds.

To best replicate the temperature ranges experienced in many potential applications of Examples of the invention, an oxidising flame was used with an acetylene:oxygen ratio of 1:1.35 (see Paul et. al., *J Eur Ceram Soc.* **2013**, 33(2):423–32 and Paul et. al., *Adv Appl Ceram.* **2016**, 115(3):158–65 for further experimental details).

The thermal imaging camera 28 (FLIR A655sc, SLIR Systems AB, Sweden) and the two-colour pyrometer 29 (METIS M3, Sensortherm, Germany) logged the surface temperature of the sample S as a function of time.

The resulting ablation on the CMC was imaged using a Keyence optical confocal microscope (VHX6000, Osaka Prefecture, Osaka, Japan).

Referring now to Figure 3A there is shown an image 30 (scale 5mm) of the ablation created during the ultra-high temperature testing of the CMC of Comparative Example 1 comprising

ZrB₂ in 100 vol.% of the heat resistant component. There is also shown a magnified image 31 (scale 2mm) of the ablation zone of image 30.

Referring now to Figure 3B there is shown an image 32 (scale 5mm) of the ablation created during the ultra-high temperature testing of the CMC of Example 1 comprising ZrB₂ in 75 vol.% and HfB₂ in 25 vol.% of the heat resistant component. There is also shown a magnified image 33 (scale 2mm) of the ablation zone of image 32.

Referring now to Figure 3C there is shown an image 34 (scale 5mm) of the ablation created during the ultra-high temperature testing of the CMC of Example 2 comprising ZrB₂ in 50 vol.% and HfB₂ in 50 vol.% of the heat resistant component. There is also shown a magnified image 35 (scale 2mm) of the ablation zone of image 34.

Referring now to Figure 3D there is shown an image 36 (scale 5mm) of the ablation created during the ultra-high temperature testing of the CMC of Example 3 comprising ZrB₂ in 25 vol.% and HfB₂ in 75 vol.% of the heat resistant component. There is also shown a magnified image 37 (scale 2mm) of the ablation zone of image 36.

Referring now to Figure 3E there is shown an image 38 (scale 5mm) of the ablation created during the ultra-high temperature testing of the CMC of Comparative Example 2 comprising HfB₂ in 100 vol.% of the heat resistant component. There is also shown a magnified image 39 (scale 2mm) of the ablation zone of image 38.

The extent of damage sustained by each CMC of Example 1 to 3, and Comparative Example 1 and 2 (shown in Figures 3A to 3E) was quantified by measuring the Mass Ablation Rate (MAR) and the Linear Ablation Rate (LAR) calculated using the following equations:

$$MAR = \frac{m_o - m_f}{t} = \frac{\Delta m}{t} \quad \text{Equation 1}$$

$$LAR = \frac{l_o - l_f}{t} = \frac{\Delta l}{t} \quad \text{Equation 2}$$

wherein subscript "o" represents initial and subscript "f" denotes final.

Therefore, lower MAR and LAR values correspond to better oxidation and ablation resistance respectively and are characteristic of superior high temperature performance.

Referring now to Figure 4, there is shown a graph 4 showing the mass ablation rates (MAR) represented by squares (■), linear ablation rates (LAR) represented by circles (●), and ablation areas represented by triangles (▲) for the high temperature performance tests shown in Figures 3A to 3E of the CMCs of Examples 1 to 3 and Comparative Examples 1 and 2.

It is evident from Figure 4 that the MAR (■), the LAR (●), and the Ablation Area (▲) for the high temperature performance testing each decrease as a function of an increasing amount of HfB₂ in ZrB₂ the CMCs of Examples 1 to 3. The CMC that exhibited the least damage (i.e. the lowest MAR, LAR, and Ablation Area values) was Example 3, comprising 75 vol.% HfB₂ and 25 vol.% ZrB₂.

Surprisingly, the CMCs of Examples 1, 2 and 3 appear to produce different molten oxide structures on the surface of the CMC compared to those based on pure ZrB₂ (Comparative Example 1) and HfB₂ (Comparative Example 2), as shown in Figures 3A to 3E, with those of Examples 2 and 3 (50-75 vol.% HfB₂ in 50-75 vol.% ZrB₂) showing marked and significant differences of structure.

Under high temperature performance testing, the CMC of Example 3 exhibits no pit or hole formation and there is also no delamination or denudation of the surface oxide. Although cracks are still present, due, we believe, to the martensitic transformation from tetragonal to monoclinic polymorphs of the resultant ZrO₂ and HfO₂ formed, the linear and mass ablation rates are very significantly reduced, as shown in Figure 4 and as compared to the pure hafnium or zirconium diborides (CE1, CE2).

Referring now to Figure 5, there is shown images 5 of CMCs of Example 2, and Comparative Examples 1 and 2 under different high temperature performance test conditions. In this test, the apparatus 2 of Figure 2 was used with the following changes to the test conditions described for the tests of Figures 3A to 3E.

The sample S was clamped in the sample holder 23 at a distance of 10 mm (instead of 12 mm) from the oxyacetylene torch 26.

For the samples S of Comparative Examples 1 and 2, the oxyacetylene torch 26 was used to heat the sample S to $\sim 2800 \pm 50$ °C with a peak heat flux of ~ 17 MW m² for 60 seconds.

5 For the sample S of Example 2, the oxyacetylene torch 26 was used to heat the sample S to $\sim 2800 \pm 50$ °C with a peak heat flux of ~ 17 MW m² for 4 minutes.

There is shown an image 51 of the ablation for the CMC of Comparative Example 1, an image 52 of the ablation for the CMC of Comparative Example 2, and an image 53 of the ablation for the CMC of Example 2.

10

There is also shown images 54, 55, 56 showing the depth of the ablation as a function of colour for the CMC of Comparative Example 1 (image 54), Comparative Example 2 (image 55) and Example 2 (image 56).

15

It is shown that the ablation zone for the Comparative Examples 1 and 2 extends much deeper in comparison to the ablation zone for Example 2. This is surprising because the test was performed for 4 minutes for Example 2 but only 60 seconds for each of the Comparative Examples. Therefore, the CMC of Example 2 has a significantly better high temperature performance than that of the CMCs of the Comparative Examples.

20

This shows that a CMC comprising a heat resistant component of a 50:50 mixture of HfB₂ and ZrB₂ (Example 2) is superior for high temperature performance to a CMC comprising a heat resistant component consisting of either ZrB₂ (Comparative Example 1) or HfB₂ (Comparative Example 2). It has been surprisingly shown that the mixture of HfB₂ and ZrB₂ produces a synergistic effect in comparison to the use of either HfB₂ or ZrB₂ alone.

25

Without wishing to be bound by any theory, it is thought that the mixture of HfB₂ and the ZrB₂ at the outer surface of the CMC oxidise to form ZrO₂ or HfO₂ at high temperatures. This forms a liquid, which flows across the surface of the CMC to provide a protective coating to prevent oxygen ingress and oxidative damage of the vulnerable carbon fibres in a CMC according to Examples of the invention. This prevents ablative damage of the ceramic material at high temperatures, e.g. above 2800 °C. This type of liquid protective coating is evident in, e.g. Figure 3A, image 31.

30

According to the Stoke-Einstein relationship, the diffusion of oxygen through the protective coating is inversely proportional to the dynamic viscosity of the coating. Therefore, to minimise the diffusivity of oxygen into the bulk composite, any liquid on the surface should have a high dynamic viscosity. This has been estimated to be ideally between 7-13 GPas
5 by Walker et. al. in *J. Am. Ceram. Soc.*, **2014**, 97 (9) 3004-3011. This publication describes that for best results, the protective liquid (in their case formed from ZrB₂ and SiC) should form with a low viscosity, wet the surface and then increase its viscosity through the loss of a volatile liquid, e.g. B₂O₃. It has also been claimed that an initial ZrO₂-SiO₂ binary melt, that had subsequently been depleted of SiO₂ due to high temperatures, was highly viscous
10 and hindered ablation damage (Chen et. al., *Corros. Sci.* **2013**, 68:168–75).

The protection mechanism of the present invention was investigated by measuring the viscosity and surface tension of liquid ZrO₂ and HfO₂ using an aerodynamic levitation (ADL) technique described by Langstaff et. al. (*Rev. Sci. Instrum.* **2013**, 84, 124901).
15

Referring now to Figures 6A and 6B, there is shown experimental data obtained from the aerodynamic levitation (ADL) technique for the following compositions: (i) HfO₂ (represented as ■); (ii) ZrO₂ (represented as ▲); (iii) Zr_{0.5}Hf_{0.5}O₂ (represented as ◆).
20

Referring first to Figure 6A, there is shown a plot 6A illustrating the viscosity as a function of temperature for (i) HfO₂ (represented as ■); (ii) ZrO₂ (represented as ▲); (iii) Zr_{0.5}Hf_{0.5}O₂ (represented as ◆). A literature value 61 for ZrO₂ (Atomic and electronic structures of an extremely fragile liquid” Shinji Kohara *et al*, *Nature Communications*, 2014) was included in Figure 6A as verification for the experimental values.
25

Referring also to Figure 6B, there is shown a plot 6B illustrating the surface tension as a function of temperature for (i) HfO₂ (represented as ■); (ii) ZrO₂ (represented as ▲); (iii) Zr_{0.5}Hf_{0.5}O₂ (represented as ◆).
30

It was expected from the prior art (Langstaff et. al., *Rev. Sci. Instrum.* **2013**, 84, 124901; Chen et. al., *Corros Sci.* **2013**, 68:168–75) that the protective mechanism of the CMC of Example 2 of the invention (comprising 50 vol.% HfB₂ and 50 vol.% ZrB₂) would result from a highly viscous coating of oxidised Zr_{0.5}Hf_{0.5}O₂ to hinder ablation damage.

Surprisingly, the data shown in Figures 6A and 6B show that the viscosity and surface tension for each of (i) HfO_2 (represented as ■); (ii) ZrO_2 (represented as ▲); (iii) $\text{Zr}_{0.5}\text{Hf}_{0.5}\text{O}_2$ (represented as ◆) are of a similar magnitude to one another.

5 Evidently, the liquid $\text{Zr}_{0.5}\text{Hf}_{0.5}\text{O}_2$ has a much lower viscosity than, for example 7-13 GPa as described in the prior art, and yet it remains adhered to the CMC sample surface for both Example 2 and Example 3 to hinder ablation damage. This contradicts the teachings of the prior art and as such, is a surprising result.

10 Therefore, at high temperatures, e.g. above 2800 °C, the ablation damage is quantitatively and qualitatively less for ceramic materials comprising both HfB_2 and ZrB_2 in comparison to ceramic materials comprising HfB_2 only or ZrB_2 only. Moreover, the exact composition of the UHTC can be tailored to suit specific needs. Zirconium diboride is less dense (and thus weighs less per unit volume) than hafnium diboride. Also, zirconium diboride is significantly
15 cheaper than its hafnium counterpart. Accordingly, significant performance enhancements can be achieved with significant weight savings. This is beneficial in many likely uses of the composition of the invention.

A part, for example, can be made to have varying physical characteristics across and/or
20 through it. For example, the ratio of hafnium diboride to zirconium diboride may be the same or may vary across and/or through the ceramic material. For example, the ceramic material may comprise a first zone or region where there is a preponderance of hafnium diboride and a second region where there is a preponderance of zirconium diboride and/or a third region where there is an equal ration of hafnium diboride and zirconium diboride. In such a
25 way a first portion of a part may have the highest temperature resistance, whereas a second portion may have a lower temperature resistance but be lighter (as may be achieved by increasing the amount of zirconium diboride as compared to the amount of hafnium diboride). This can be conveniently be achieved using the injection process set out above.

30 The ceramic material according to the invention provides a lower density, lower cost, high melting point material, which gives rise to less ablative damage than materials of the prior art.

It will be appreciated by those skilled in the art that several variations to the aforementioned
35 embodiments are envisaged without departing from the scope of the invention.

It will also be appreciated by those skilled in the art that any number of combinations of the
aforementioned features and/or those shown in the appended drawings provide clear
advantages over the prior art and are therefore within the scope of the invention described
5 herein.

CLAIMS

1. An ultra-high temperature ceramic material comprising hafnium diboride and zirconium diboride.
- 5
2. A ceramic material according to Claim 1, wherein the ceramic material is monolithic.
3. A ceramic material according to Claim 1, wherein the ceramic material further comprises a substrate.
- 10
4. A ceramic material according to Claim 3, wherein the substrate comprises or is formed from a porous body, for example formed comprising fibre, e.g. a carbon fibre and/or a carbon fibre preform.
- 15
5. A ceramic material according to Claim 3 or 4, wherein the ceramic material forms a matrix with the substrate.
6. A ceramic material according to any preceding Claim, wherein the ceramic material is a carbon fibre reinforced ceramic composite.
- 20
7. A ceramic material according to any preceding Claim, wherein the ceramic material does not comprise silicon or compounds of silicon, e.g. silicon carbide, other than unavoidable impurities.
- 25
8. An ultra-high temperature ceramic material comprising a heat resistant component, the heat resistant component comprising:
 between 15 to 85 vol.% HfB₂; and
 between 15 to 85 vol.% ZrB₂.
- 30
9. A ceramic material according to Claim 8, wherein the heat resistant component comprises between 25 to 75 vol.% HfB₂ and between 25 to 75% ZrB₂.
10. A ceramic material according to Claim 8 or 9, wherein the heat resistant component comprises between 50 to 75 vol.% HfB₂ and between 50 to 25 vol.% ZrB₂.
- 35

11. A ceramic material according to any of Claims 8 to 10, wherein the heat resistant component consists of HfB_2 and ZrB_2 .
12. An ultra-high temperature ceramic matrix composite, the composite comprising a ceramic matrix component and a substrate, the ceramic matrix component comprising a heat resistant component comprising:
between 15 to 85 vol.% HfB_2 ; and
between 15 to 85 vol.% ZrB_2 .
13. A ceramic matrix composite according to Claim 12, wherein the substrate comprises a porous body, for example comprises a fibre component, e.g. a carbon fibre component.
14. A method of fabricating an ultra-high temperature ceramic matrix composite, the method comprising:
providing a substrate;
providing a composition comprising a heat resistant component, the heat resistant component comprising HfB_2 and ZrB_2 ;
impregnating the substrate with the composition;
optionally, curing the substrate comprising the composition to form a ceramic matrix within the reinforcing component;
pyrolyzing the substrate comprising the ceramic matrix.
15. A method according to Claim 14, wherein the substrate comprises a porous body and/or comprises fibres, e.g. carbon fibres.
16. A method according to Claim 14 or 15, wherein the composition comprises a resin, for example a phenolic resin and/or a solvent, for example acetone.
17. A method according to any of Claims 14 to 16, wherein the heat resistant component comprises between 15 to 85 vol.% HfB_2 and between 15 to 85 vol.% ZrB_2 .
18. A method according to any of Claims 14 to 17, wherein the heat resistant component comprises between 25 to 75 vol.% HfB_2 and between 25 to 75 vol.% ZrB_2 .

19. A method according to any of Claims 14 or 18, wherein the heat resistant component comprises between 50 to 75 vol.% HfB₂ and between 50 to 25 vol.% ZrB₂.
- 5 20. A method according to any of Claims 14 or 19, wherein the heat resistant component consists of HfB₂ and ZrB₂.
21. A method according to any of Claims 14 to 20, wherein impregnating the substrate comprises injecting the composition into the substrate.
- 10 22. A method according to any of Claims 14 to 21, wherein impregnating the substrate comprises impregnating the substrate with the composition under vacuum.
- 15 23. A method according to any of Claims 14 to 22, wherein impregnating the substrate comprises a two-stage pressure assisted impregnation technique comprising: (i) injecting the composition into the substrate; and (ii) supplying a vacuum to the substrate in the presence of the composition to impregnate the substrate with the composition.
- 20 24. A method according to Claim 23, wherein step (i) injecting the composition into the substrate, is performed before step (ii) supplying a vacuum to the substrate in the presence of the composition to impregnate of the substrate with the composition.

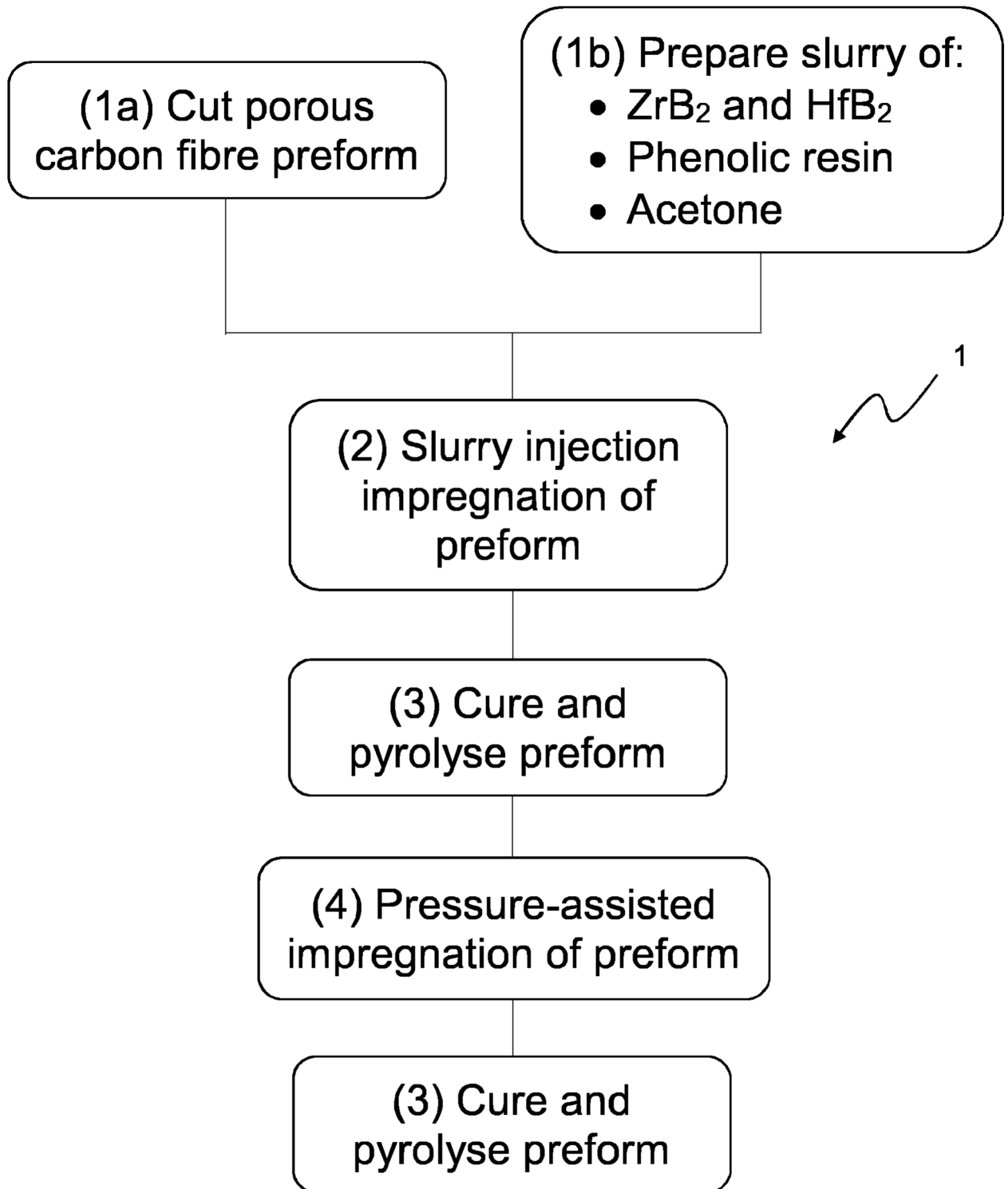

FIGURE 1A

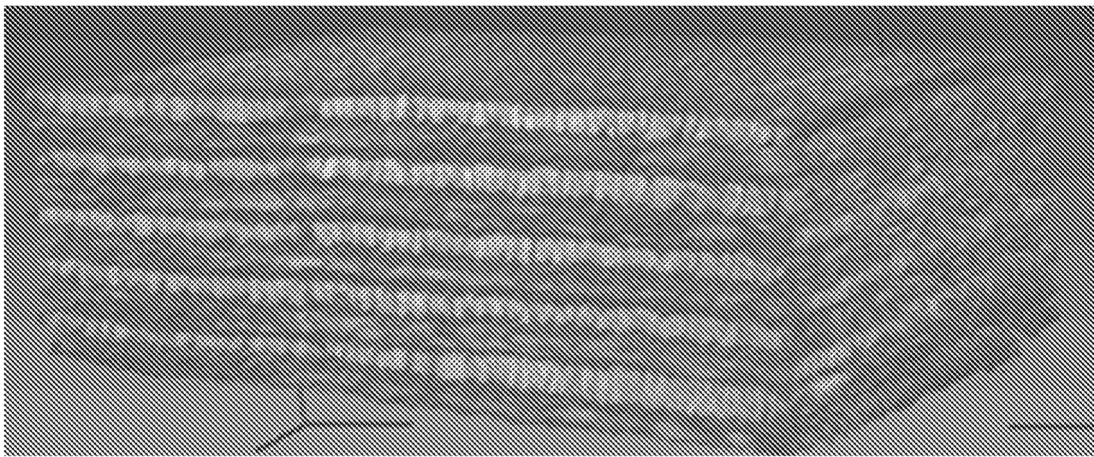
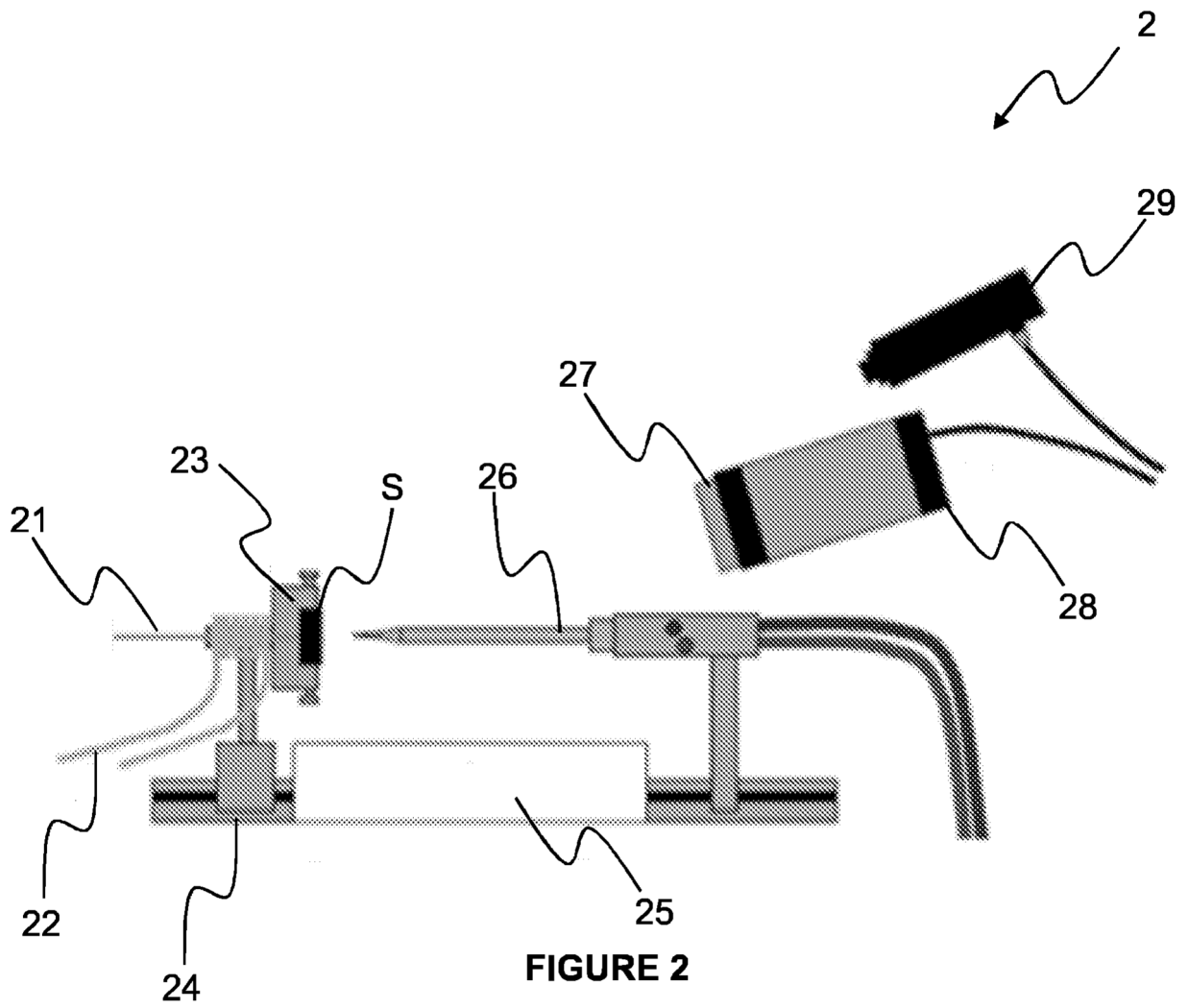
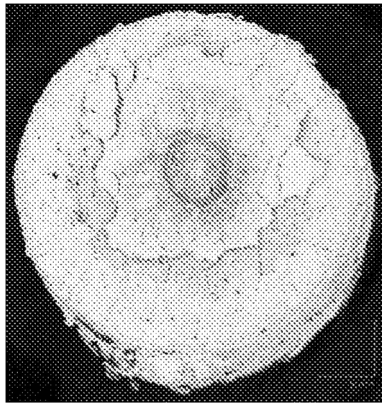

FIGURE 1B



Comparative Example 1



30

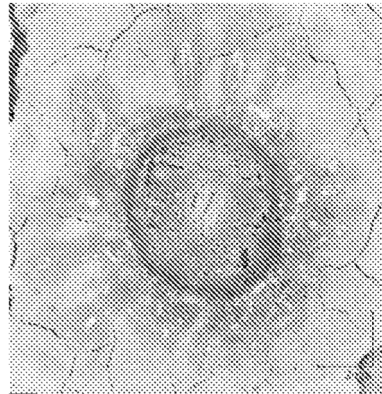

31

FIGURE 3A

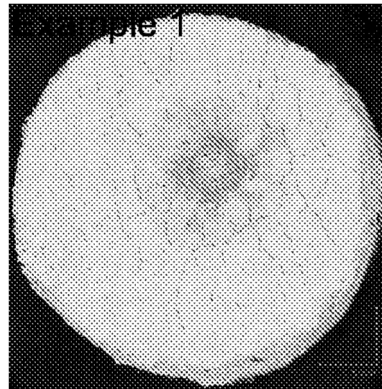

32

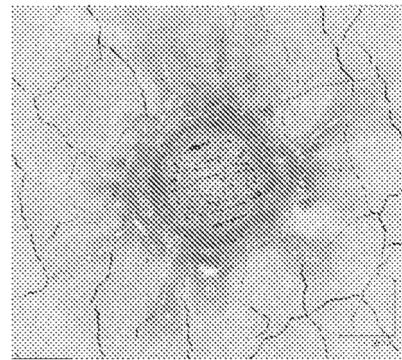

33

FIGURE 3B

Example 2

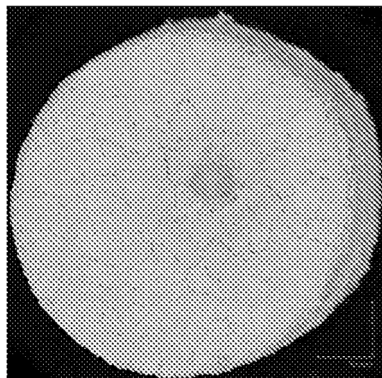

34

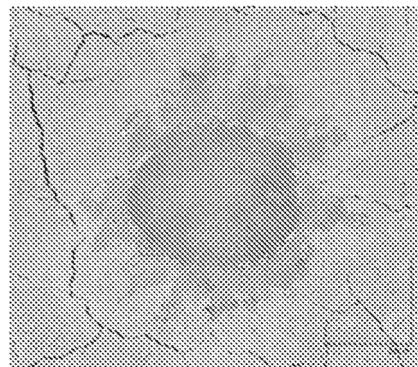

35

FIGURE 3C

Example 3

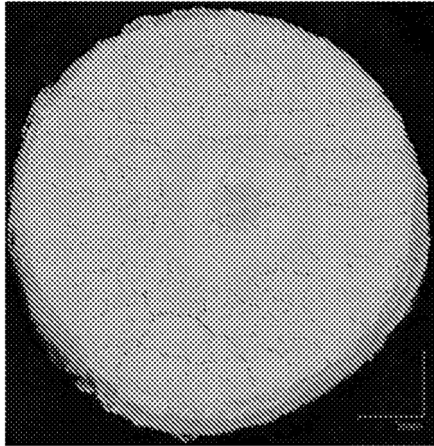

36

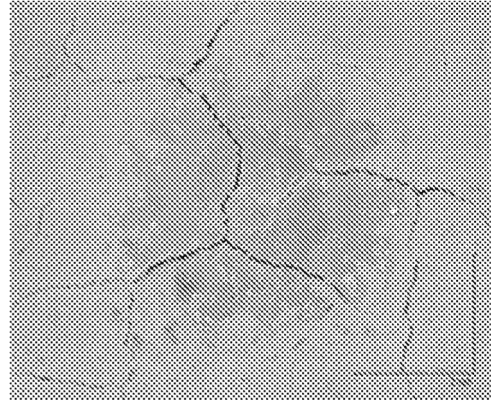

37

FIGURE 3D

Comparative Example 2

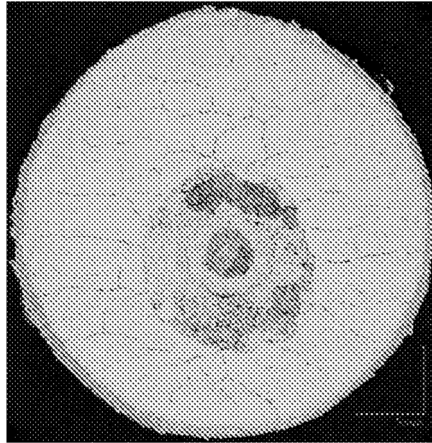

38

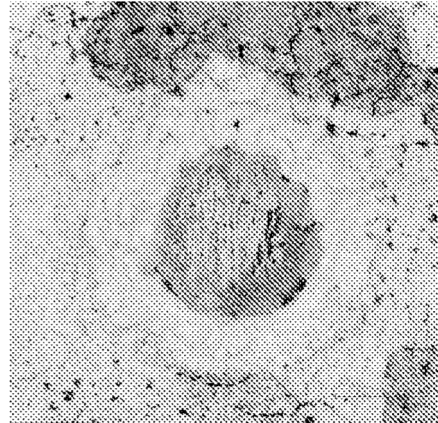

39

FIGURE 3E

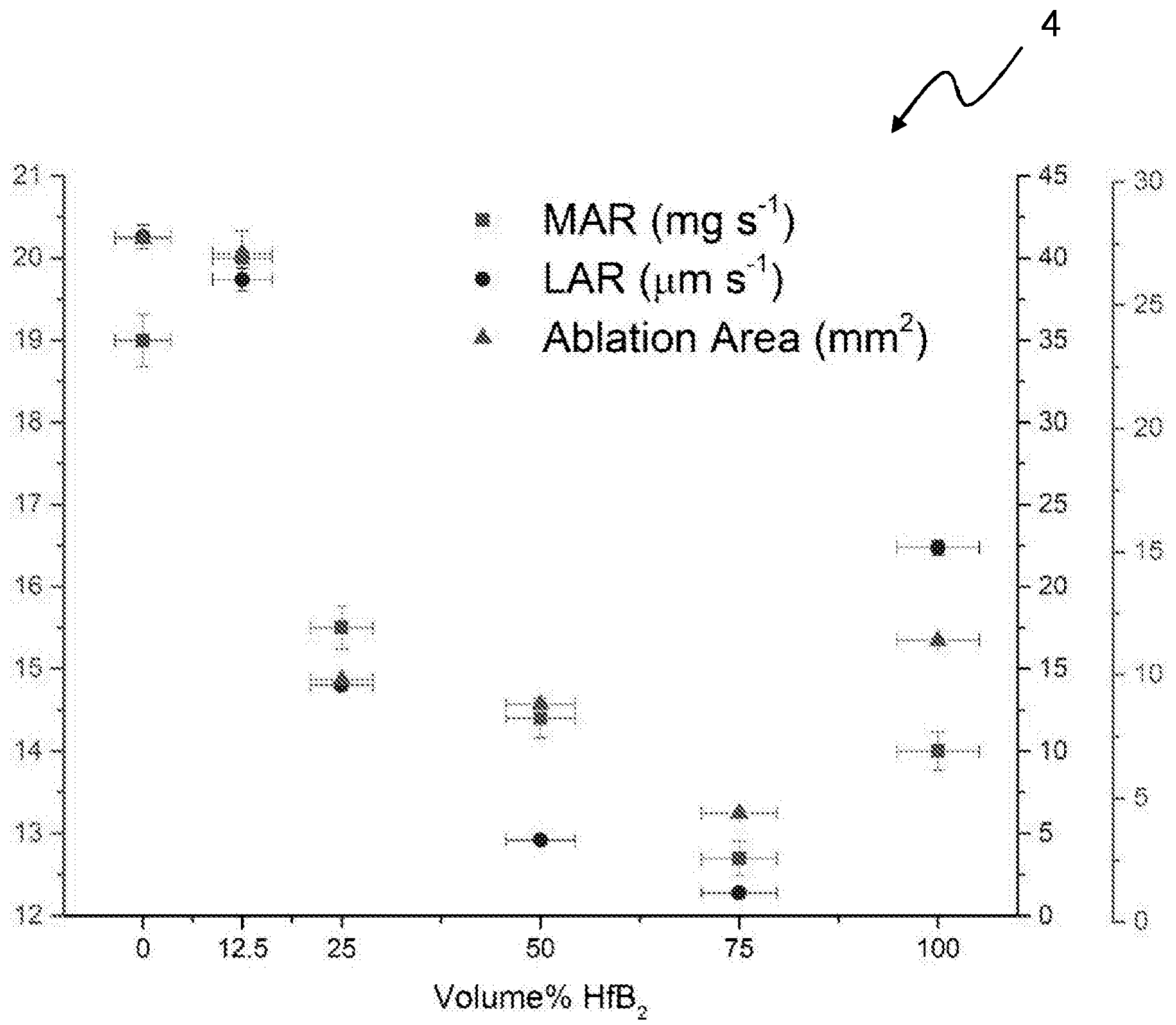

FIGURE 4

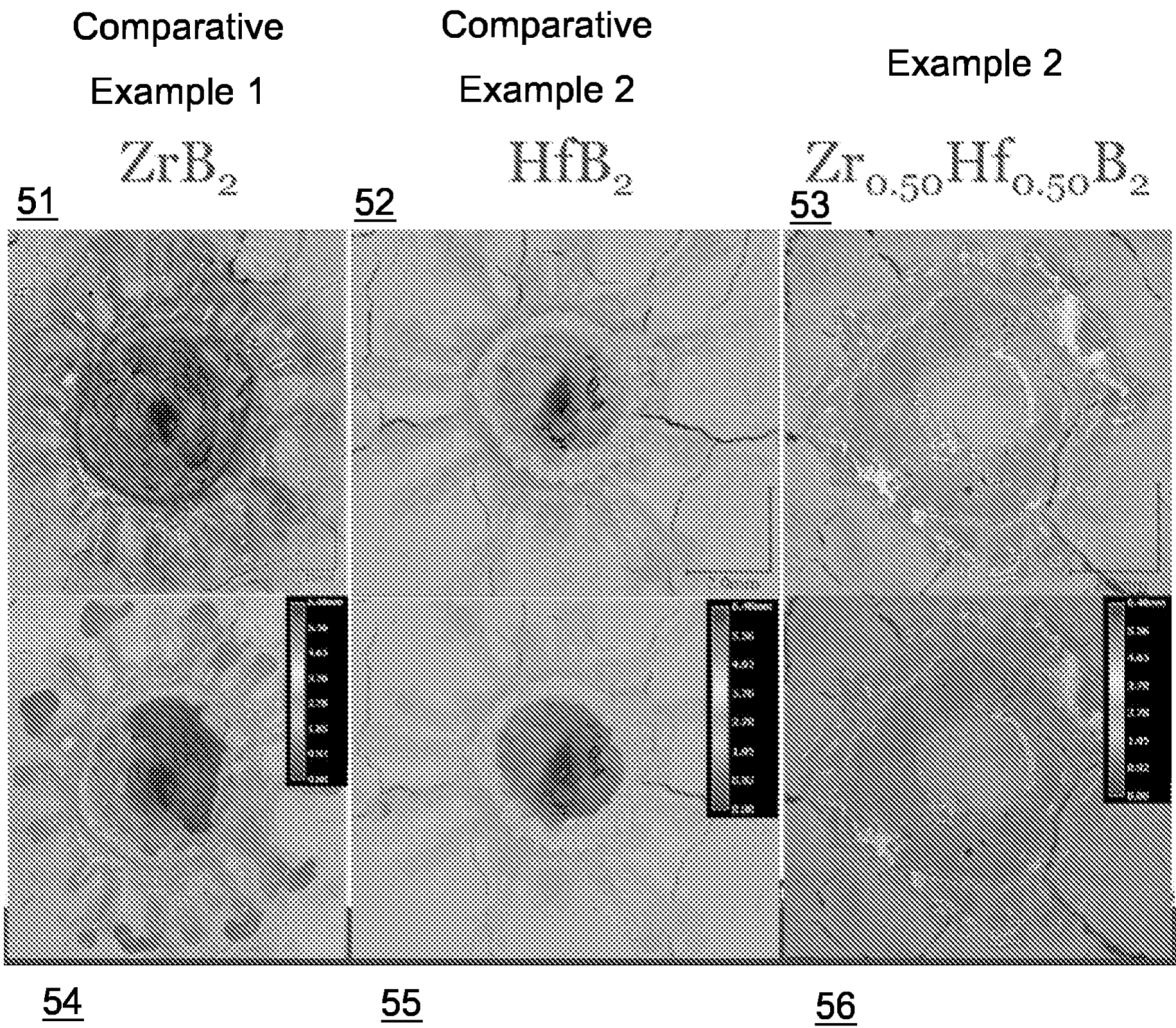
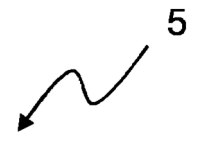

FIGURE 5

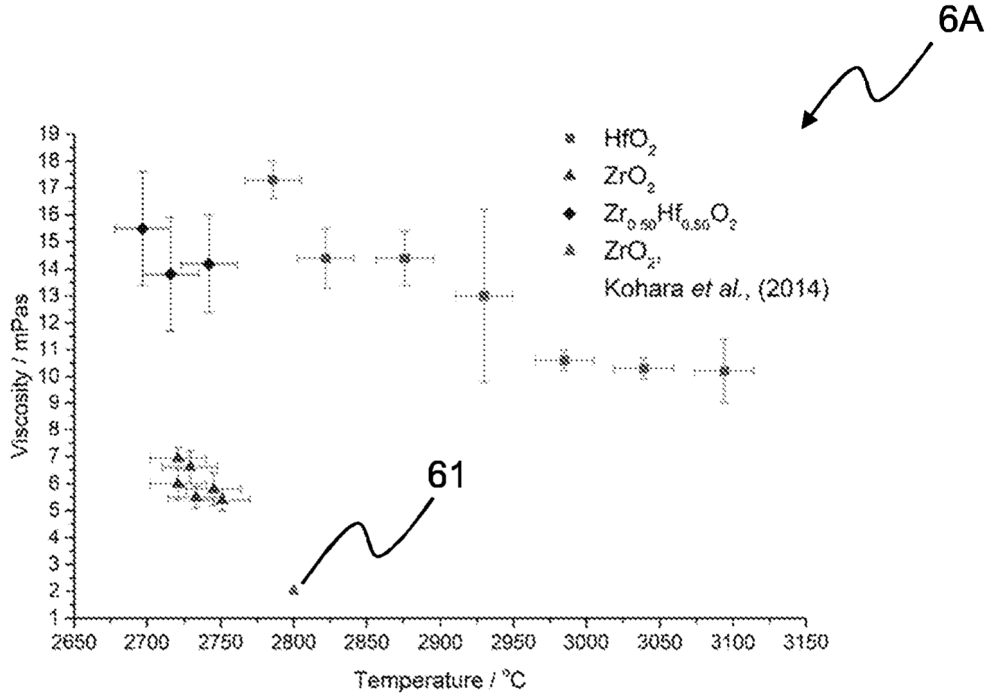

FIGURE 6A

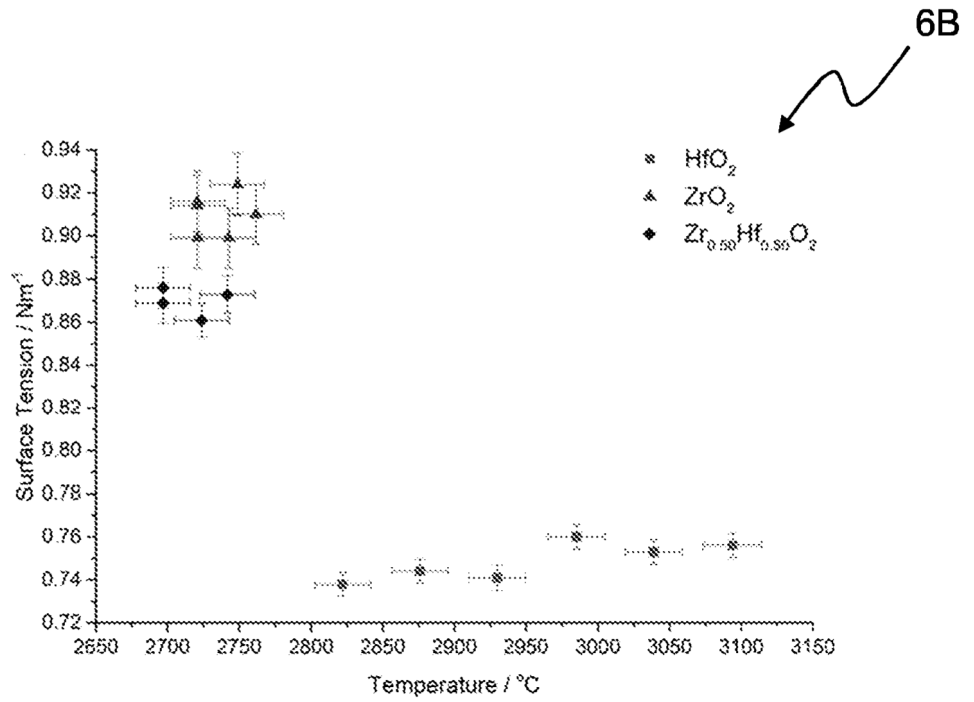

FIGURE 6B

INTERNATIONAL SEARCH REPORT

International application No PCT/GB2020/050951

A. CLASSIFICATION OF SUBJECT MATTER
 INV. C04B35/58 C04B35/80 C04B35/626
 ADD.

According to International Patent Classification (IPC) or to both national classification and IPC

B. FIELDS SEARCHED

Minimum documentation searched (classification system followed by classification symbols)
 C04B

Documentation searched other than minimum documentation to the extent that such documents are included in the fields searched

Electronic data base consulted during the international search (name of data base and, where practicable, search terms used)
 EPO-Internal, WPI Data

C. DOCUMENTS CONSIDERED TO BE RELEVANT

Category*	Citation of document, with indication, where appropriate, of the relevant passages	Relevant to claim No.
X	RU 2 618 567 C1 (FED GOSUDARSTVENNOE BYUDZHETNOE UCHREZHDENIE NAUKI INST OBSHCHEJ I NEO) 4 May 2017 (2017-05-04) paragraphs [0018], [0045], [0046] -----	1,2
X	NISAR AMBREEN ET AL: "Processing, microstructure and mechanical properties of HfB2-ZrB2-SiC composites: Effect of B4C and carbon nanotube reinforcements", INTERNATIONAL JOURNAL OF REFRACTORY METALS AND HARD MATERIALS, vol. 81, 19 February 2019 (2019-02-19), pages 111-118, XP085651971, ISSN: 0263-4368, DOI: 10.1016/J.IJRMHM.2019.02.014 part 2.1 ----- -/--	1,2,8,9

Further documents are listed in the continuation of Box C. See patent family annex.

* Special categories of cited documents :

<p>"A" document defining the general state of the art which is not considered to be of particular relevance</p> <p>"E" earlier application or patent but published on or after the international filing date</p> <p>"L" document which may throw doubts on priority claim(s) or which is cited to establish the publication date of another citation or other special reason (as specified)</p> <p>"O" document referring to an oral disclosure, use, exhibition or other means</p> <p>"P" document published prior to the international filing date but later than the priority date claimed</p>	<p>"T" later document published after the international filing date or priority date and not in conflict with the application but cited to understand the principle or theory underlying the invention</p> <p>"X" document of particular relevance; the claimed invention cannot be considered novel or cannot be considered to involve an inventive step when the document is taken alone</p> <p>"Y" document of particular relevance; the claimed invention cannot be considered to involve an inventive step when the document is combined with one or more other such documents, such combination being obvious to a person skilled in the art</p> <p>"&" document member of the same patent family</p>
---	---

Date of the actual completion of the international search 5 June 2020	Date of mailing of the international search report 18/06/2020
---	---

Name and mailing address of the ISA/ European Patent Office, P.B. 5818 Patentlaan 2 NL - 2280 HV Rijswijk Tel. (+31-70) 340-2040, Fax: (+31-70) 340-3016	Authorized officer <p style="text-align: center; font-size: 1.2em;">Raming, Tomas</p>
--	--

INTERNATIONAL SEARCH REPORT

International application No

PCT/GB2020/050951

C(Continuation). DOCUMENTS CONSIDERED TO BE RELEVANT		
Category*	Citation of document, with indication, where appropriate, of the relevant passages	Relevant to claim No.
X	CN 107 746 281 A (UNIV CHINA MINING) 2 March 2018 (2018-03-02)	1,7-11
Y	claim 1; example 3 -----	17-20
X	US 4 929 417 A (WATANABE TADAHIKO [JP] ET AL) 29 May 1990 (1990-05-29) claim 1; table 1 -----	1,2,7
X	DATABASE WPI Week 200846 28 May 2008 (2008-05-28) Thomson Scientific, London, GB; AN 2008-H15354 XP002799253, & CN 101 186 505 A 28 May 2008 (2008-05-28) embodiment 1 -----	1-3,8,9, 12,13
X	US 2019/062223 A1 (SCITI DILETTA [IT] ET AL) 28 February 2019 (2019-02-28)	1-6, 14-16,22
Y	claim 1; example 1 -----	21,23,24
A	Anonymous: "H.C. Starck Grade A Zirconium Diboride, ZrB ₂ ", 1 January 2019 (2019-01-01), XP055701016, Retrieved from the Internet: URL: http://www.matweb.com/search/datasheet.aspx?matguid=edcda644867442478bd4918096302373&ckck=1 [retrieved on 2020-06-04] the whole document -----	1-24
Y	CN 106 866 151 A (HARBIN INSTITUTE TECHNOLOGY) 20 June 2017 (2017-06-20) claim 1 -----	21,23,24
X	BALAK Z ET AL: "Application of Taguchi L32orthogonal design to optimize flexural strength of ZrB ₂ -based composites prepared by spark plasma sintering", INTERNATIONAL JOURNAL OF REFRACTORY METALS AND HARD MATERIALS, ELSEVIER, AMSTERDAM, NL, vol. 55, 18 November 2015 (2015-11-18), pages 58-67, XP029362326, ISSN: 0263-4368, DOI: 10.1016/J.IJRMHM.2015.11.009 table 1 -----	1-3,5,6, 8,12
	-/--	

INTERNATIONAL SEARCH REPORT

International application No

PCT/GB2020/050951

C(Continuation). DOCUMENTS CONSIDERED TO BE RELEVANT		
Category*	Citation of document, with indication, where appropriate, of the relevant passages	Relevant to claim No.
X	A Paul ET AL: "UHTC-carbon fibre composites: Preparation, oxyacetylene torch testing and characterisation", J eur cer soc, 13 September 2012 (2012-09-13), pages 423-432, XP055701364, Retrieved from the Internet: URL: https://www.sciencedirect.com/science/article/pii/S0955221912004669?via%3Dihub [retrieved on 2020-06-04]	1-7, 14-16
Y	experimental section -----	17-20

INTERNATIONAL SEARCH REPORT

Information on patent family members

International application No PCT/GB2020/050951
--

Patent document cited in search report	Publication date	Patent family member(s)	Publication date
RU 2618567	C1	04-05-2017	-----
CN 107746281	A	02-03-2018	NONE
US 4929417	A	29-05-1990	NONE
CN 101186505	A	28-05-2008	NONE
US 2019062223	A1	28-02-2019	CN 108698939 A 23-10-2018 EP 3408245 A1 05-12-2018 US 2019062223 A1 28-02-2019 WO 2017130134 A1 03-08-2017
CN 106866151	A	20-06-2017	NONE